

ISSN 1998-0663

# BUSINESS INFORMATICS

HSE SCIENTIFIC JOURNAL

№2(40)-2017

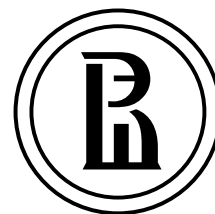

## CONTENTS

### ***Information systems and technologies in business***

*T.K. Kravchenko, S.N. Bruskin*

Prioritization of requirements for effective support  
of the communication process with customers  
of a commercial bank..... 7

*A.N. Biryukov*

Strategic management in the IT department..... 17

*Y.A. Zelenkov*

Information efficiency, information design  
and information system of an organization ..... 25

### ***Mathematical methods and algorithms of business informatics***

*A.P. Afanas'ev, S.M. Dzyuba, I.I. Emelyanova*

Horner's Scheme for investigation of solutions  
of differential equations with polynomial right-hand side..... 33

*D.S. Kokorev*

An algorithm for determining the optimal variant  
of a cut gem with maximal mass and specified  
symmetry deviations ..... 40

*S.A. Fomin, R.L. Belousov*

Detecting semantic duplicates in short news items..... 47

### ***Modeling of social and economic systems***

*A.A. Gorbunov, E.A. Isaev, A.F. Morgunov*

A simulation model for educational process planning  
in an institution of higher education ..... 57

*I.V. Ilyin, A.A. Grigoreva,*

*I.M. Zapivakhin*

Architectural Solution as a tool for planning and  
approval of changes in projects for information systems  
implementation and customization ..... 68

*Publisher:*

National Research University  
Higher School of Economics

**Subscription index  
in the «Rospechat» catalogue –  
72315**

The journal is published quarterly

*The journal is included  
into the list of peer reviewed  
scientific editions established  
by the Supreme Certification  
Commission of the Ministry  
of Education and Science  
of the Russian Federation*

*Editor-in-Chief:*

**A. Golosov**

*Deputy Editor-in-Chief*

**Y. Koucheryav**

*Computer Making-up:*

**O. Bogdanovich**

*Website Administration:*

**I. Khrustaleva**

*Address:*

33, Kirpichnaya Street, Moscow,  
105187, Russian Federation

Tel./fax: +7 (495) 771-32-38

<http://bijournal.hse.ru>

E-mail: [bijournal@hse.ru](mailto:bijournal@hse.ru)

*Circulation – 500 copies*

Printed in HSE Printing House  
3, Kochnovsky Proezd, Moscow,  
Russian Federation

© National Research University  
Higher School of Economics

# ABOUT THE JOURNAL

**B**usiness Informatics is a peer reviewed interdisciplinary academic journal published since 2007 by National Research University Higher School of Economics (HSE), Moscow, Russian Federation. The journal is administered by School of Business Informatics. The journal is published quarterly.

The mission of the journal is to develop business informatics as a new field within both information technologies and management. It provides dissemination of latest technical and methodological developments, promotes new competences and provides a framework for discussion in the field of application of modern IT solutions in business, management and economics.

The journal publishes papers in the areas of, but not limited to:

- ◆ data analysis and intelligence systems
- ◆ information systems and technologies in business
- ◆ mathematical methods and algorithms of business informatics
- ◆ software engineering
- ◆ Internet technologies
- ◆ business processes modeling and analysis
- ◆ standardization, certification, quality, innovations
- ◆ legal aspects of business informatics
- ◆ decision making and business intelligence
- ◆ modeling of social and economic systems
- ◆ information security.

The journal is included into the list of peer reviewed scientific editions established by the Supreme Certification Commission of the Ministry of Education and Science of the Russian Federation.

The journal is included into Russian Science Citation Index (RSCI) database on the Web of Science platform.

International Standard Serial Number (ISSN) 1998-0663.

Editor-in-Chief: Dr. Alexey Golosov – President of FORS Development Center, Moscow, Russian Federation.

---

## EDITORIAL BOARD

### *EDITOR-IN-CHIEF*

#### **Alexey Golosov** –

President of FORS Development Center, Russian Federation

### *DEPUTY EDITOR-IN-CHIEF*

#### **Yevgeni Koucheryavy** –

Professor, Department of Electronics and Communication Engineering, Tampere University of Technology, Finland

### *EDITORIAL BOARD*

#### **Habib Abdulrab** –

Professor, Mathematical and Software Engineering Department, National Institute of Applied Sciences – Institut national des sciences appliquées de Rouen (INSA de Rouen), Rouen, France

#### **Sergey Avdoshin** –

Professor, Head of School of Software Engineering, National Research University Higher School of Economics, Russian Federation

#### **Andranik Akopov** –

Professor, Department of Business Analytics, National Research University Higher School of Economics, Russian Federation

#### **Fuad Aleskerov** –

Professor, Head of Department of Mathematics, National Research University Higher School of Economics, Russian Federation

#### **Anton Afanasyev** –

Leading Researcher, Laboratory of Social Modeling, Central Economics and Mathematics Institute, Russian Academy of Science, Russian Federation

#### **Eduard Babkin** –

Professor, Department of Information Systems and Technologies, National Research University Higher School of Economics, Russian Federation

#### **Alex Bayer** –

Head of KAFAN FX Information Services, New York, USA

#### **Alexander Baranov** –

Deputy Head of Central Scientific and Research Computing Center, Federal Tax Service of Russia, Russian Federation

#### **Jorg Becker** –

Vice-Rector, Professor, Director of European Research Center for Information Systems (ERCIS), University of Munster, Germany

#### **Vladimir Belov** –

Professor, Department of Computational and Applied Mathematics, Ryazan State Radio Engineering University, Russian Federation

#### **Andrey Gribov** –

Director General, CyberPlat Company, Russian Federation

#### **Alexander Gromov** –

Professor, Head of Department of Modeling and Business Process Optimization, National Research University Higher School of Economics, Russian Federation

#### **Vladimir Gurvich** –

Invited Professor and Researcher, Rutgers Center for Operations Research, Rutgers, The State University of New Jersey, USA

#### **Laurence Jacobs** –

Professor, Medical School, University of Zurich, Switzerland

#### **Iosif Diskin** –

Academic Supervisor, Chairmen of Scientific and Expert Council, Russian Public Opinion Research Center (VCIOM); Member of the Council, The Russian Public Chamber; Russian Federation

#### **Kurt Sandkuhl** –

Professor, Head of Department of Business Information Systems, University of Rostock, Germany

#### **Nikolay Ilyin** –

Deputy Head, Administration of Special Communication, Federal Security Guard, Russian Federation

#### **Dmitry Isaev** –

Associate Professor, Department of Business Analytics, National Research University Higher School of Economics, Russian Federation

#### **Valery Kalyagin** –

Professor, Head of Department of Applied Mathematics and Informatics, National Research University Higher School of Economics, Russian Federation

#### **Maria Kamennova** –

Director General, BPM Logic, Russian Federation

#### **Tatiana Kravchenko** –

Professor, Head of Department of Business Analytics, National Research University Higher School of Economics, Russian Federation

#### **Sergey Kuznetsov** –

Professor, Head of School of Data Analysis and Artificial Intelligence, National Research University Higher School of Economics, Russian Federation

#### **Mikhail Lugachev** –

Professor, Head of Department of Economic Informatics, Lomonosov Moscow State University, Russian Federation

#### **Svetlana Maltseva** –

Professor, Head of Department of Innovation and Business in Information Technologies, National Research University Higher School of Economics, Russian Federation

#### **Peter Major** –

Vice-chairman, Radiocommunication Advisory Group of International Telecommunication Union (ITU), vice-chairman of the UN Commission on Science and Technology for Development (CSTD), Geneva, Switzerland

#### **Boris Mirkin** –

Professor, School of Data Analysis and Artificial Intelligence, National Research University Higher School of Economics, Russian Federation

#### **Vadim Mottl** –

Professor, Department of Information Security Management, Tula State University, Russian Federation

#### **Dmitry Palchunov** –

Head of Department of General Informatics, Novosibirsk State University, Russian Federation

#### **Panagote (Panos) Pardalos** –

Distinguished Professor and University of Florida Research Foundation Professor, Director of Center for Applied Optimization, Department of Industrial and Systems Engineering, University of Florida, USA

#### **Albert Silantyev** –

Professor, Department of Information Business Systems, National University of Science and Technology «MISIS», Russian Federation

#### **Victor Taratukhin** –

Managing Director, European Research Center for Information Systems (ERCIS), University of Munster, Germany

#### **Mikhail Ulyanov** –

Professor, School of Software Engineering, National Research University Higher School of Economics, Russian Federation

# БИЗНЕС- ИНФОРМАТИКА

НАУЧНЫЙ ЖУРНАЛ НИУ ВШЭ

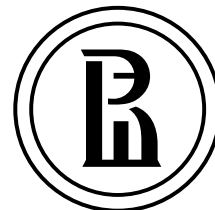

## СОДЕРЖАНИЕ

### *Информационные системы и технологии в бизнесе*

*Т.К. Кравченко, С.Н. Брускин*

Приоритизация требований для эффективной поддержки процесса коммуникаций с клиентами коммерческого банка ..... 7

*А.Н. Бирюков*

Стратегическое управление ИТ-службой ..... 17

*Ю.А. Зеленков*

Информационная эффективность, информационный дизайн и информационная система организации..... 25

### *Математические методы и алгоритмы бизнес-информатики*

*А.П. Афанасьев, С.М. Дзюба, И.И. Емельянова*

Схема Горнера для исследования решений дифференциальных уравнений с полиномиальной правой частью..... 33

*Д.С. Кокорев*

Алгоритм поиска оптимального варианта огранки драгоценного камня максимальной массы с заданными отклонениями от симметричности..... 40

*С.А. Фомин, Р.Л. Белоусов*

Поиск семантических дубликатов в коротких новостных сообщениях..... 47

### *Моделирование социальных и экономических систем*

*А.А. Горбунов, Е.А. Исаев, А.Ф. Моргунов*

Имитационная модель поддержки планирования учебного процесса в высшем учебном заведении..... 57

*И.В. Ильин, А.А. Григорьева, И.М. Запивахин*

Архитектурное Решение как инструмент планирования и согласования изменений в проектах внедрения и кастомизации информационных систем ..... 68

*Издатель:*

Национальный  
исследовательский университет  
«Высшая школа экономики»

Подписной индекс  
в каталоге агентства  
«Роспечать» – 72315

Выпускается ежеквартально

*Журнал включен в Перечень  
российских рецензируемых  
научных журналов,  
в которых должны быть  
опубликованы основные научные  
результаты диссертаций  
на соискание ученых степеней  
доктора и кандидата наук*

*Главный редактор*  
**А.О. Голосов**

*Заместитель главного редактора*  
**Е.А. Кучерявый**

*Компьютерная верстка*  
**О.А. Богданович**

*Администратор веб-сайта*  
**И.И. Хрусталёва**

*Адрес редакции:*  
105187, г. Москва, ул. Кирпичная, д. 33  
Тел./факс: +7 (495) 771-32-38  
<http://bijournal.hse.ru>  
E-mail: [bijournal@hse.ru](mailto:bijournal@hse.ru)

За точность приведенных сведений  
и содержание данных,  
не подлежащих открытой публикации,  
несут ответственность авторы

**При перепечатке ссылка на журнал  
«Бизнес-информатика» обязательна**

*Тираж 500 экз.*

Отпечатано в типографии НИУ ВШЭ  
г. Москва, Кочновский проезд, 3

© Национальный  
исследовательский университет  
«Высшая школа экономики»

# О ЖУРНАЛЕ

«**Б**изнес-информатика» – рецензируемый междисциплинарный научный журнал, выпускаемый с 2007 года Национальным исследовательским университетом «Высшая школа экономики» (НИУ ВШЭ). Администрирование журнала осуществляется школой бизнес-информатики НИУ ВШЭ. Журнал выпускается ежеквартально.

Миссия журнала – развитие бизнес-информатики как новой области информационных технологий и менеджмента. Журнал осуществляет распространение последних разработок технологического и методологического характера, способствует развитию соответствующих компетенций, а также обеспечивает возможности для дискуссий в области применения современных информационно-технологических решений в бизнесе, менеджменте и экономике.

Журнал публикует статьи по следующей тематике:

- ◆ анализ данных и интеллектуальные системы
- ◆ информационные системы и технологии в бизнесе
- ◆ математические методы и алгоритмы бизнес-информатики
- ◆ программная инженерия
- ◆ Интернет-технологии
- ◆ моделирование и анализ бизнес-процессов
- ◆ стандартизация, сертификация, качество, инновации
- ◆ правовые вопросы бизнес-информатики
- ◆ принятие решений и бизнес-интеллект
- ◆ моделирование социальных и экономических систем
- ◆ информационная безопасность.

В соответствии с решением президиума Высшей аттестационной комиссии Российской Федерации журнал включен в Перечень российских рецензируемых научных журналов, в которых должны быть опубликованы основные научные результаты диссертаций на соискание ученых степеней доктора и кандидата наук, по следующим группам научных специальностей: 05.13.00 – информатика, вычислительная техника и управление; 05.25.00 – документальная информация; 08.00.00 – экономические науки.

Журнал входит в базу Russian Science Citation Index (RSCI) на платформе Web of Science.

Журнал зарегистрирован Федеральной службой по надзору в сфере связи, информационных технологий и массовых коммуникаций (Роскомнадзор), свидетельство ПИ № ФС77-66609 от 08 августа 2016 г.

Международный стандартный серийный номер (ISSN) 1998-0663.

Главный редактор: Голосов Алексей Олегович, кандидат технических наук, Президент компании «ФОРС – Центр разработки».

## ГЛАВНЫЙ РЕДАКТОР

**Голосов Алексей Олегович** – кандидат технических наук, Президент компании «ФОРС – Центр разработки»

## ЗАМЕСТИТЕЛЬ ГЛАВНОГО РЕДАКТОРА

**Кучерявый Евгений Андреевич** – PhD, профессор департамента электроники и коммуникаций, Технологический университет Тампере, Финляндия

## ЧЛЕНЫ РЕДКОЛЛЕГИИ

**Абдульраб Абиб** – PhD, профессор департамента математики и программной инженерии, Национальный институт прикладных наук, Руан, Франция

**Авдошин Сергей Михайлович** – кандидат технических наук, профессор, руководитель департамента программной инженерии, Национальный исследовательский университет «Высшая школа экономики»

**Акопов Андраник Сумбатович** – доктор технических наук, профессор кафедры бизнес-аналитики, Национальный исследовательский университет «Высшая школа экономики»

**Алескеров Фуад Тагиевич** – доктор технических наук, профессор, руководитель департамента математики, Национальный исследовательский университет «Высшая школа экономики»

**Афанасьев Антон Александрович** – доктор экономических наук, и.о. ведущего научного сотрудника лаборатории социального моделирования, Центральный экономико-математический институт РАН

**Бабкин Эдуард Александрович** – кандидат технических наук, PhD, профессор кафедры информационных систем и технологий, Национальный исследовательский университет «Высшая школа экономики»

**Байер Алекс** – PhD, Директор KAFAN FX Information Services, Нью-Йорк, США

**Баранов Александр Павлович** – доктор физико-математических наук, заместитель директора ФГУП «Главный научно-исследовательский вычислительный центр Федеральной налоговой службы»

**Беккер Йорг** – PhD, проректор, профессор, директор Европейского исследовательского центра в области информационных систем (ERCIS) Мюнстерского университета, Мюнстер, Германия

**Белов Владимир Викторович** – доктор технических наук, профессор кафедры вычислительной и прикладной математики, Рязанский государственный радиотехнический университет

**Грибов Андрей Юрьевич** – кандидат экономических наук, Генеральный директор компании «КиберПлат»

**Громов Александр Игоревич** – кандидат химических наук, профессор, заведующий кафедрой моделирования и оптимизации бизнес-процессов, Национальный исследовательский университет «Высшая школа экономики»

**Гурвич Владимир Александрович** – PhD, приглашенный профессор и исследователь, Центр исследования операций, Ратгерский университет (Университет Нью-Джерси), США

**Джейкобс Лоренц** – PhD, профессор медицинского факультета, Университет Цюриха, Швейцария

**Дискин Иосиф Евгеньевич** – доктор экономических наук, научный руководитель, председатель Научно-экспертного совета, Всероссийский центр изучения общественного мнения (ВЦИОМ); член Совета Общественной палаты Российской Федерации

**Зандкуль Курт** – PhD, заведующий кафедрой информационных систем для бизнеса, Университет Ростока, Германия

**Ильин Николай Иванович** – доктор технических наук, член-корреспондент Академии криптографии РФ, заместитель начальника Управления специальной связи, Федеральная служба охраны Российской Федерации (ФСО России)

**Исаев Дмитрий Валентинович** – кандидат экономических наук, доцент кафедры бизнес-аналитики, Национальный исследовательский университет «Высшая школа экономики»

**Калягин Валерий Александрович** – доктор физико-математических наук, профессор, заведующий кафедрой прикладной математики и информатики, Национальный исследовательский университет «Высшая школа экономики»

**Каменнова Мария Сергеевна** – кандидат технических наук, Генеральный директор компании «Логика ВРМ»

**Кравченко Татьяна Константиновна** – доктор экономических наук, профессор, заведующая кафедрой бизнес-аналитики, Национальный исследовательский университет «Высшая школа экономики»

**Кузнецов Сергей Олегович** – доктор физико-математических наук, профессор, руководитель департамента анализа данных и искусственного интеллекта, Национальный исследовательский университет «Высшая школа экономики»

**Лугачев Михаил Иванович** – доктор экономических наук, профессор, заведующий кафедрой экономической информатики, Московский государственный университет им. М.В. Ломоносова

**Мальцева Светлана Валентиновна** – доктор технических наук, профессор, заведующая кафедрой инноваций и бизнеса в сфере информационных технологий, Национальный исследовательский университет «Высшая школа экономики»

**Мейер Питер** – PhD, заместитель директора консультативной группы по радиокоммуникациям, Международный телекоммуникационный союз (ITU), заместитель руководителя Комиссии ООН по науке и технологиям, Женева, Швейцария

**Миркин Борис Григорьевич** – доктор технических наук, профессор департамента анализа данных и искусственного интеллекта, Национальный исследовательский университет «Высшая школа экономики»

**Моттль Вадим Вячеславович** – доктор технических наук, профессор кафедры информационной безопасности, Тульский государственный университет

**Пальчунов Дмитрий Евгеньевич** – доктор физико-математических наук, заведующий кафедрой общей информатики, Новосибирский государственный университет

**Пардалос Панайот (Панос)** – PhD, почетный профессор, директор центра прикладной оптимизации, департамент промышленной и системной инженерии, Университет Флориды, США

**Силантьев Альберт Юрьевич** – доктор технических наук, профессор кафедры информационных бизнес систем, Национальный исследовательский технологический университет «МИСиС»

**Таратухин Виктор Владимирович** – кандидат технических наук, PhD, руководитель научной группы Европейского исследовательского центра в области информационных систем (ERCIS) Мюнстерского университета, Мюнстер, Германия

**Ульянов Михаил Васильевич** – доктор технических наук, профессор департамента программной инженерии, Национальный исследовательский университет «Высшая школа экономики»

# Prioritization of requirements for effective support of the communication process with customers of a commercial bank

## Tatiana K. Kravchenko

Professor, Head of Department of Business Analytics  
National Research University Higher School of Economics  
Address: 20, Myasnitskaya Street, Moscow, 101000, Russian Federation  
E-mail: tkravchenko@hse.ru

## Sergey N. Bruskin

Associate Professor, Department of Business Analytics  
National Research University Higher School of Economics  
Address: 20, Myasnitskaya Street, Moscow, 101000, Russian Federation  
E-mail: sbruskin@hse.ru

### Abstract

Requirements prioritization is performed by business analysts in order to analyze stated requirements and to define the required capabilities of a potential solution that will fulfill stakeholder needs. During the analysis, the business analyst transforms needs and informal concerns of stakeholders into formal solution requirements which describe the behavior of solution components in sufficient detail. Furthermore, requirements analysis may be performed to develop models of the current state of an organization. These models can be used in order to validate the solution scope with business and stakeholders, to analyze the current state of an organization to identify opportunities for improvement, or to assist stakeholders in understanding that current state.

The requirements prioritization task includes the following elements. First, these are business cases which state key goals and measures of success for a project or organization. Priorities should be aligned with those goals and objectives. Business needs can be used as an alternative to the business case if no business case has been defined. Second, the prioritization requires that these requirements have been stated by stakeholders. Third, the list of stakeholders, annotated with their levels of authority and influence, is used to determine which stakeholders need to participate in prioritization.

As a result, the several techniques and recommendations stated in the BABOK® Guide have been applied for requirements prioritization in a case study of a conventional commercial bank. The business needs of the organization have been identified. The main problems of the communication management process have been formulated. Underlying sources of the problem have been illustrated on a fishbone diagram (also known as an Ishikawa or cause-and-effect diagram). The list of stakeholders and the requirements have been made. The MoSCoW technique has been applied in order to identify four groups of requirements, which differ from each other by the impact the results of their implementation have on the solution of the identified problems. The list of prioritized requirements should be used on the next stages of the project. It may be useful for the project manager when planning works on the solution implementation. The results of this work should also help the stakeholders develop a common point of view on the strategic goals of the project.

**Key words:** requirements, requirements prioritization, fishbone diagram, MoSCoW technique.

**Citation:** Kravchenko T.K., Bruskin S.N. (2017) Prioritization of requirements for effective support of the communication process with customers of a commercial bank. *Business Informatics*, no. 2 (40), pp. 7–16. DOI: 10.17323/1998-0663.2017.2.7.16.

## Introduction

Both increasing level of competition and current economic difficulties are forcing the banking business to move from price-based competition towards a customer-centric one. More and more banking institutions are implementing a CRM (Customer Relationship Management) concept on both operational and analytical levels. However, the initial complexity and inconsistency of banking systems cause a number of difficulties during the implementation of any new module into the existing IT infrastructure of the organization.

These difficulties are imposed on usual constraints associated with any project, such as budgetary, temporal, or qualitative constraints. In this regard, it is not enough to identify key requirements of the future solution while planning activities on implementing new modules in the IT infrastructure. The fulfillment of all the identified requirements is likely to violate one or several project constraints. Therefore, a process of requirements prioritization is one of the key stages of the requirements analysis process. Prioritization of requirements ensures that analysis and implementation efforts focus on the most critical business requirements [1–6].

The following work provides the results of requirements prioritization in a case study of a conventional commercial bank. The work objective is to put into practice requirements prioritization techniques which are suggested in “A Guide to the Business Analysis Body of Knowledge® (BABOK® Guide)”. The object of the study is the process of customer communication management established in the bank. The subject being analyzed is the list of requirements set by the various divisions of the bank for the developing communication support system.

### 1. Determining the reasons preventing the bank from achieving target sales figures

The leading business activity for the bank being considered was consumer lending in partnership with large retail chains and small regional companies. Recently a new strategic development course has been chosen, with the goal of increasing the loan portfolio by means of diversifying credit products. Since the level of competition in the market of general purpose loans is high, they decided to enter the market by means of cross-selling. This sales method, which implies loan offers to existing customers, was chosen for its relative cheapness and ease of implementation.

Nevertheless, some time after the new strategic development course was approved, it became clear that the hoped-for increase in the amount of general purpose loans to existing customers could not be fulfilled. In order

to determine possible underlying sources of the problem, a root cause analysis was performed by graphing a fish-bone (also known as Ishikawa) diagram (*Figure 1*). This tool helps to focus on the cause of a problem versus the solution and organizes ideas for further analysis. The diagram serves as a map depicting possible cause-and-effect relationships [2].

### 2. Identification of problems in setting up communications with the bank’s clients

Because of the fact that the cross-selling mechanism is based on continuous communications with the bank’s customers, the main sources of the problem were discovered in areas of planning and implementing communications with customers, which in turn stem from the technical imperfection of the communication management system available in the bank.

As part of the cross-selling process established in the bank, the following mechanism of planning and implementing communications was used. Clients could be offered a new credit product via e-mail messages, sms messages, and phone calls.

Because of the intensive growth of the bank’s client base, as well as the increase in the share of general purpose loans in the overall loan portfolio of the organization, the problems of the existing solution for setting up communications with clients that hampered the further development of cross-selling became obvious:

- ◆ the inconsistency of the systems used to plan and implement communications (each of the three types of communications was supported by separate and unrelated systems). At the same time, there was a need to make a centralized decision to conduct all types of communications in order to consistently develop relations with the bank’s clients and to harmoniously increase the client base without distortions to a particular client segment;
- ◆ the processes of marketing communications management were automated on a low level. For instance, employees of departments responsible for different stages of the process often had to manually create files, format them and put them in the necessary directories;
- ◆ the marketing communication management processes were not flexible enough to comply with rapidly changing risk and communication policies of the bank. Lack of flexibility led to situations where the communication strategy chosen for a certain customer at the beginning of month did not correspond with the real credit offer to the customer at the moment of contact.



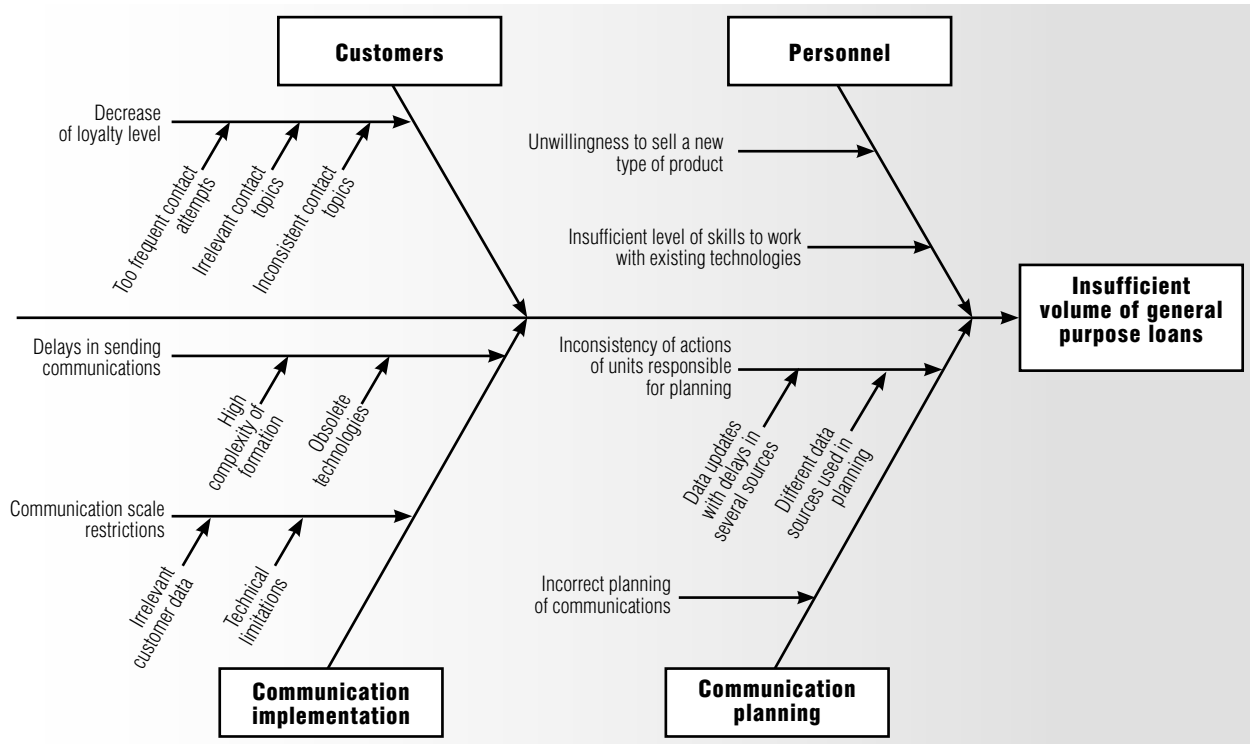

Fig.1. The cause-and-effect diagram

All the stated problems along with the new strategic development course chosen by the bank top management established a new business need of the organization. The need was to obtain a new tool that supports a centralized, automated, and flexible communications management process. It was decided to develop a unified information system for managing client communications which will completely replace some outdated modules and will also eliminate restrictions which exist in other modules.

### 3. Identification of stakeholders for the development of a module to support processes of interaction with customers

In Table 1, stakeholders of the project to develop a communication process support system are shown. The stakeholders' roles and responsibilities in the process of communication formation and execution are listed (in parentheses in the field "Stakeholder" the abbreviations for the names of divisions are shown to be used in prospect).

Table 1.

#### List of stakeholders

Stakeholder	Role in the process	Level of interest	Level of influence
Customer Service Department (CS)	The division executes the major part of the direct contacts with customers. It is responsible for delivery of both sms and e-mail messages, incoming line support, and outbound call-down. The division is an owner of the Customer Service process	High	High
Cross Sales Management Department (XS)	The division forms the list of contacts for further call-down on sales topics. It is responsible for the upper-level communication strategy and for customer relationships development. The division is an owner of the Cross Sales process	High	High
Card Portfolio Management Department (CP)	The division is responsible for communication strategy development with the card owners of the bank	High	Medium
Remote Sales Management Department (RS)	The division is responsible for the development of the Internet and mobile bank. It uses sms- and e-mail mailing technologies to attract customers to the new remote sales channels	Medium	Medium
Information Security and Anti-Fraud Department (AF)	The division is responsible for setting up and sending out validation messages in cases when the customer performs one of the key actions: product activation, transaction execution, initiating a change of personal data, establishing a personal cabinet in the Internet bank, etc	High	High
Collection Department (CL)	The division is an owner of the Arrears Collection process	Low	Low

In order to better understand the subject area and the boundaries of the future solution, we interviewed representatives of each of the selected stakeholder groups involved in the communication management process [1]. *Table 2* provides information on all types of communications with clients established in the bank. The owners and executors of the communications are also shown.

#### 4. Functions of the bank for communication with customers

The communication activities that are established in the bank can be divided into several groups by their functions. The primary function of communication with customers is to offer them a new loan product; thus, the process of contact with the client is directly related to

achieving the organization's strategic goal, which is to increase the share of general purpose loans in the total loan portfolio of the bank.

The second function of the communication process with customers is related to maintaining a stronger relationship with clients who already have an active product of the bank. Thus, the communication process is aimed at positively influencing the level of customer loyalty, which, in its turn, positively affects the company's future earnings. Communications concerning customer awareness of information security and countering fraud can also be called as actions aimed at increasing customer loyalty level. Activities aimed at informing clients of their arrears are considered in this case to be increasing the level of communications consistency. For instance, while forming a new message to the client, it is neces-

*Table 2.*

**Types of communication established in the bank**

Area	Goal	Stakeholder	Channel of communication	Communication description
Sales promotion	To increase the volume of card transactions	Card Portfolio Management	sms, e-mail, call	Informing the client of the bonus program
	To increase the amount of sales	Card Portfolio Management, Cross Sales Management	sms, e-mail, call	Informing the client of current offers
	To increase the amount of sales	Remote Sales Management	Internet bank	Informing the client of current offers
Customer service	To raise customer awareness	Customer Service	sms, call	Informing of progress status for the client's appeal
	To increase the customer loyalty level	Customer Service	sms, call	Providing information on the current status of payments at the request of the client
		Customer Service	sms, call	Sending a reminder of a planned visit to the office
Informing about active contracts	To raise customer awareness	Card Portfolio Management, Cross Sales Management	sms, e-mail	Sending transactional status messages
	To increase the level of penetration of the Internet bank	Remote Sales Management	sms, e-mail	Informing the client of the existence of arrears according to GIS GMS data
	To increase the customer loyalty level	Card Portfolio Management	sms, e-mail	Informing the client about the card readiness status
Securing customer data	To improve customer data security level	Information Security	sms	Notification of client data changes
		Information Security	sms	Sending card validation requisites
		Information Security	e-mail	Sending information letters on countering fraud
		Remote Sales Management, Information Security	sms	Sending Internet bank actions validation requisites
Collection of arrears	To raise customer awareness	Collection	sms, call	Sending a reminder of payment
	To issue a warning	Collection	sms, call	Informing the client of 5 and 1 days before reaching the debt
		Collection	sms, call	Informing the client of existing arrears
	To enforce legislation	Collection	sms, call	Informing the client about transfer of the case to a collection agency

sary to make sure that its content will not contradict the current status of the client and will not mislead the customer. Indirectly, this function of communication with the client can also be attributed to the group aimed at increasing customer loyalty.

**5. The problems of the bank's communication with customers and requirements of stakeholders for a future solution**

The stakeholder requirements for the future solution are presented in the format of business initiatives, in which each of the stakeholder groups tried to formulate the problems facing the division while performing communication activities and the requirements for their solution (*Table 3*). The problems facing the stakeholder groups were identified during brainstorming of the divisions' employees [2].

**6. Need to prioritize requirements**

In view of the project's time limits, resource and financial limitations of the project, the list of stakeholder requirements should be systematized, and the relative importance of each requirement should be determined. These priorities will be used in order to determine which requirements should be implemented first during the development of the communication process support system.

During the process of prioritizing the requirements of stakeholders, it was decided to assess the received requirements in terms of the urgency of their implementation. Since the initiative to develop a new communication module comes from the business sector, which is responsible for increasing the share of cross-sales in the bank's portfolio, it is necessary to make sure that the requirements being implemented are primarily aimed at increasing the amount of general purpose loans and solve the fundamental problems formulated during the process of identifying the business need. In this case, the highest priority of the requirement will mean that this requirement must be implemented at the earliest possible stage of the project.

The main problems identified in a communication management process of the bank (*Figure 1*) boil down to the technical limitations of the existing communication support system, which:

- ◆ cause difficulties in the process of forming communications with customers;
- ◆ complicate the process of implementing planned communications;
- ◆ reduce the level of customer loyalty level due to ex-

cessively frequent, contradictory and irrelevant communications.

It is advisable to assign the highest priority to requirements whose implementation contributes to the elimination of technical imperfections in the communication support system and makes the existing processes of forming and implementing communications with customers more efficient. Requirements whose implementation involves adding new functionality to the system or contributing to the emergence of new types of communication with customers can be postponed until the next round of system development.

**7. Ranking requirements according to the MoSCoW methodology**

In order to assess the value of the requirements in terms of their compliance with the main business goals set for the future solution, the requirements have been ranked using the MoSCoW (Must, Should, Could, Will not) analysis technique [2; 3], where:

◆ Must – requirements that must be satisfied in the final solution for the solution to be considered a success. We consider it mandatory to fulfill the requirement in case its implementation contributes to increasing the efficiency of the processes of both forming and implementing communications simultaneously, and also directly increases the loyalty level of the bank's clients;

◆ Should – high-priority items that should be included in the solution if possible. We consider it desirable to fulfill the requirement in case its implementation contributes to the efficiency of either the formation process, or the process of implementing communication with the subsequent increase in the level of customer loyalty;

◆ Could – a requirement which is considered desirable but not necessary. We consider it desirable but not necessary to fulfill the requirement in cases when implementation contributes to the efficiency of either the formation process, or the process of implementing communication;

◆ Won't or Would (W) – the requirement that stakeholders have agreed will not be implemented in a given release, but may be considered for the future. The fulfillment of such requirements does not directly affect the solution of the priority problems identified in the analysis. The value of implementing them more likely refers to the expansion of the possibilities of communication with customers, rather than addressing current problems in the processes of forming and implementing communications.

Table 3.

## Stakeholder requirements

Stakeholder	Problem	Requirement	Short sign
Cross Sales Management Department	The inability to directly put the list of target audience of the campaign into the sms message gateway. As a result, files are transferred manually on a daily basis	To automate the process of downloading the client database to the gateway directory for sending sms messages, excluding manual file sharing between XS and CS units	XS1
Cross Sales Management Department	The inability to send e-mail messages over the entire existing client database through the existing system due to the technical limitation on the number of messages sent	To add an e-mail channel as a full-fledged communication channel with the client, and to remove technical restrictions on the number of message recipients	XS2
Cross Sales Management Department	The existing technical restriction on the speed of sending e-mail messages (up to 200,000 messages per month), which impedes the full use of the communication channel	To increase the speed of sending e-mail messages to 1 million per hour with the ability to adjust the speed of sending both before the initiation of communication, and directly during the dispatch	XS3
Cross Sales Management Department	The inability to automatically add the client to the stop-list in case he/she refused to receive messages via e-mail	To automatically update the stop-list with information about clients' refusals to receive e-mail messages. To add the new e-mail address to the stop-list in case of changing client contact data	XS4
Cross Sales Management Department	The inability to get e-mail delivery statistics (delivered / read / target action done), which impedes the full analysis of the communication and its further improvement	To provide an opportunity to generate a report on the status of e-mail messages delivery	XS5
Customer Service Department	There is no information on customer communications in the CRM system	To connect the communication module with the CRM system in order to provide information on all the communications carried out with the client in online mode	CS1
Customer Service Department	There is no possibility to identify incorrect / nonexistent e-mail addresses and phone numbers in the client database	To provide an opportunity to centrally form the list of invalid contacts, and the possibility to set the rules by which contacts fall into the invalid list	CS2
Customer Service Department	The number of communications in which the client is involved exceeds the acceptable level. The situation leads to a decrease of customer loyalty level	To provide an opportunity to control the intensity of the client's participation in communications through all channels	CS3
Customer Service Department	There are no pre-configured limits on the budget for communication for each cost-center, as well as there is no system of alerts / prohibitions on dispatch in case of budget excess	To track information on budget spent on communications in online mode, to set up notifications when approaching the threshold value	CS4
Collection Department	There is no possibility to change or stop sending sms messages during the day when the status of the customer's debt changes	The ability to change communication with the client online in the event of changing its status of debt	CL1
Collection Department	There is no detailed information on the type and the source of sms message in existing reports	To implement a unified communication reference book	CL2
Collection Department	There are no unified reports on customer communications held within the same campaign but by means of different communication channels	To log multi-channel communication actions within a single campaign	CL3
Card Portfolio Management Department	The inability to support real-time message sending in order to quickly react to card transactions made by the customer	To integrate the communication module being developed with both CRM (Customer Relationship management) and RTM (Real Time Marketing) systems	CP1
Card Portfolio Management Department	The lack of a tool to automatically inform the client of the readiness status of the reissued cards	To connect the communication module with the credit cards database in order to automatically send messages in accordance with the status of the client's card	CP2
Remote Sales Management Department	The department is forced to manually create a list of customers who have left an application for an incoming call on a service line on the bank's website	To integrate the CRM system outbound module with the bank's website form by means of the new communication module	RS1
Information Security and Anti-Fraud Department	The department is forced to manually confirm the relevance of clients' personal data in cases when changes have been made in the verification system	To automatically update the client data in cases when changes have been made in the verification system	AF1
Information Security and Anti-Fraud Department	There is a 1-hour delay between the client's activation action with the credit card and the sending of the validation message to him/her to confirm the action. The situation leads to a decrease of the card activation rate	To reduce the response time for card activation requests up to 5 minutes	AF2
Information Security and Anti-Fraud Department	The inability to directly download the client database with the suspicious activity indicator from AFSF to sms messages or outbound calls gateway; as a consequence, the need to use additional CS resources to transfer files manually	To automate the process of downloading the client database to the gateway directory for sending sms messages, excluding manual file sharing between AF and CS units	AF3

Table 4.

**MoSCoW priority matrix**

Requirement code	Requirement description	Justification of the requirement assessment	M	S	C	W
XS1	To automate the process of downloading the client database to the gateway directory for sending sms messages	Implementation of this requirement will save human resources of both XS and CS units, however it will not directly lead to the simplification of communication planning and implementation processes, nor will it contribute to increasing the level of customer loyalty				X
XS2	To add an e-mail channel as a full-fledged communication channel with the client	The implementation of the requirement will remove the existing restriction on the number of target audience for the communication, which will facilitate the implementation of communication, as well as attract new loyal customers		X		
XS3	To increase the speed of sending e-mail messages to 1 million per hour with the ability to adjust the speed of sending	The implementation of the requirement will help optimize the use of CS department human resources, will increase the flexibility of the process of interaction with customers, and will increase the level of customer loyalty		X		
XS4	To automatically update the stop-list with the information about clients' refusals	The implementation of the requirement will lead to an increase in the consistency level of communications, which positively affects customer loyalty level and is helpful for reducing costs	X			
XS5	To provide the opportunity to generate a report on the status of e-mail messages delivery	The implementation of the requirement will increase the efficiency of the processes of forming and implementing communications with customers		X		
CS1	To connect communication module with the CRM system	The implementation of the requirement helps to increase the level of customer loyalty, since it will reduce the number of uncoordinated and inconsistent communications with the clients			X	
CS2	To provide the opportunity to centrally form the list of invalid contacts	The implementation of the requirement will improve the coherence of communications, reduce costs, and simplify the processes of communications formation and implementation	X			
CS3	To provide the opportunity to control the intensity of the client's participation in communications	The implementation of the requirement will improve the coherence of communications, reduce costs, and simplify the processes of communications formation and implementation	X			
CS4	To track information on budget spent on communications in online mode	The implementation of the requirement will reduce costs, and simplify the processes of communications formation and implementation			X	
CL1	To connect the communication module with the customer debt database	The implementation of the requirement will reduce the response time to the client's status change (which increases the level of customer loyalty), and will reduce the level of inconsistency of data in different modules of the communication management support system		X		
CL2	To implement the unified communication reference book	The implementation of the requirement will increase the level of coordination between various communications of different divisions, and also will reduce the costs of the processes of communication formation and implementation	X			
CL3	To log multi-channel communication actions	Implementation of the requirement will save human resources of the CL unit, however, it will not affect the effectiveness of the processes of communication formation and implementation in a positive way				X
CP1	To integrate the communication module being developed with both CRM (Customer Relationship management) and RTM (Real Time Marketing) systems	The implementation of the requirement will increase the level of customer loyalty. However, it presumes the creation of a new communication channel and will not resolve the problems identified in the existing processes				X
CP2	To connect the communication module with the credit cards database	The implementation of the requirement will help promptly inform clients of the status of the card re-issue. This will positively affect the level of customer loyalty			X	
RS1	To integrate the CRM system outbound module with the bank's website form by means of the new communication module	The implementation of the requirement will save human resources of the RS division. Also, it will positively affect the level of customer loyalty			X	
AF1	To automatically update the client data in cases when changes have been made in the verification system	The implementation of the requirement will help increase the efficiency of the communication formation process, and it will also expand the volume of a valid client base. It will increase the level of client loyalty on account of client data relevance increase	X			
AF2	To reduce the response time to card activation requests up to 5 minutes	The implementation of the requirement will increase the level of customer loyalty			X	
AF3	To automate the process of downloading the client database to the gateway directory for sending sms messages	The implementation of the requirement will increase the speed of response to suspicious activities, which will increase the level of customer loyalty in the existing communication process			X	

The results of applying MoSCoW technique to the stakeholder requirements are shown in *Table 4*. There is a priority matrix with the following columns. Stakeholder requirements are briefly formulated in the column “Requirement description”. Consequences of the requirement implementation are stated in the column “Justification of the requirement assessment”, along with the consistency level of the implementation results for each requirement with the strategic goals of the project. Depending on the power of consistency of results of requirement realization and major business problems, the marks Must, Should, Could or Won’t are assigned.

Thus, based on the results of MoSCoW prioritization technique, the primary priority group has been identified. This includes requirements which when implemented contribute to the efficiency of existing communications management processes at a fundamental level, namely:

- ◆ allows the bank to synchronize data in various modules of the communication support system with customers;
- ◆ increases the level of correctness of data on the bank’s customers.

The requirements that are desirable to perform can be described in the following way:

- ◇ facilitate partial data synchronization in some modules of the communication support system;
- ◇ increase the efficiency of the processes of communication formation and implementation.

The requirements that are desirable but not necessary to be fulfilled will increase the level of customer loyalty with regard to communication with them in the context of existing types of interactions, but technological problems of the formation and implementation of communication are practically not solved by them. Such requirements may be implemented when enough resources and time remain.

Requirements for which implementation can be postponed are mainly focused on increasing the level of customer loyalty by adding new types of interaction with clients. Implementation of these requirements is more likely to be useful in the future, when the current problems of communications management processes have been resolved.

## Conclusion

This work provides the results of requirements prioritization in a case study of a conventional commercial bank. Several techniques and recommendations stated in BABOK® Guide have been applied. First, all the inputs stated for the task of requirements prioritization have been taken into consideration:

- the business need of the organization has been identified. It may be described as a need to obtain a new tool that supports a centralized, automated, and flexible communications management process;
- based on the description of different communication types established in the organization, the main problems of the communication management process have been formulated. The underlying sources of the problem have been illustrated on a Fishbone diagram;
- the list of stakeholders has been made. It consists of the divisions that are directly involved into the communication management process;
- the list of stakeholder requirements has been made.

The basis for requirements prioritization has been chosen. It is the consistency level between the results of requirement implementation and the problems present in the current communication management process. The MoSCoW technique has been applied in order to identify four groups of requirements which differ from each other by the impact the results of their implementation have on the solution of the identified problems.

The list of requirements with identified priorities allows to more clearly identify the objectives of the project, including for project sponsors. In this case, the goals of the project are to eliminate technical imperfections of the current system of communication with customers, as well as to facilitate the process of forming and implementing various types of communications.

The list of prioritized requirements may be useful for the project manager while planning works on implementation of the solution. The results of the work should also help the stakeholders develop a common point of view on the strategic goals of the project. Keeping to the list of prioritized requirements will help the organization improve a communication management support system in short time and with consideration of the primary goals of the project. ■

## References

1. IIBA (2009) *A Guide to the Business Analysis Body of Knowledge® (BABOK® Guide)*. Version 2.0. Toronto: International Institute of Business Analysis.
2. IIBA (2015) *A Guide to the Business Analysis Body of Knowledge® (BABOK® Guide)*. Version 3. Toronto: International Institute of Business Analysis.

3. IIBA (2013) *Agile extension to the BABOK Guide*. Toronto: International Institute of Business Analysis.
4. Berander P., Andrews A. (2005) Requirements prioritization. *Engineering and managing software requirements* (eds. A. Aurum, C. Wohlin). Berlin, Heidelberg: Springer, pp. 69–94.
5. Karlsson J., Ryan K. (1997) A cost-value approach for prioritizing requirements. *IEEE Software*, no. 14 (5), pp. 67–74.
6. Lehtola L., Kauppinen M., Kujala S. (2004) Requirements prioritization challenges in practice. *Proceedings of the 5th International Conference "Product Focused Software Process Improvement" (PROFES 2004), Kansai Science City, Japan, 5–8 April 2004*. Berlin, Heidelberg: Springer, pp. 497–508.

## Приоритизация требований для эффективной поддержки процесса коммуникаций с клиентами коммерческого банка

### Т.К. Кравченко

доктор экономических наук,  
профессор, заведующая кафедрой бизнес-аналитики  
Национальный исследовательский университет «Высшая школа экономики»  
Адрес: 101000, г. Москва, ул. Мясницкая, д. 20  
E-mail: tkravchenko@hse.ru

### С.Н. Брускин

кандидат экономических наук,  
доцент кафедры бизнес-аналитики  
Национальный исследовательский университет «Высшая школа экономики»  
Адрес: 101000, г. Москва, ул. Мясницкая, д. 20  
E-mail: sbruskin@hse.ru

#### Аннотация

Приоритизация требований выполняется бизнес-аналитиком для анализа заявленных требований и определения необходимых возможностей потенциального решения, которое будет отвечать потребностям заинтересованных сторон. В ходе анализа бизнес-аналитик преобразует потребности и неформальные проблемы заинтересованных сторон в формальные требования к решению. Кроме того, анализ требований может быть выполнен для разработки моделей текущего состояния организации. Эти модели можно использовать для проверки области решения бизнеса и заинтересованных сторон, анализа текущего состояния организации с целью выявления возможностей улучшения или для помощи заинтересованным сторонам в понимании этого состояния.

Задача определения приоритетов требований включает в себя следующие элементы. Во-первых, это бизнес-кейсы, в которых указаны ключевые цели и показатели успеха для проекта или организации. Приоритеты должны быть согласованы с этими целями и задачами. Бизнес-необходимость может быть использована как альтернатива бизнес-кейсу, если бизнес-кейсы не были подготовлены. Во-вторых, приоритизация требований требует, чтобы эти требования были заявлены заинтересованными сторонами. В-третьих, должен быть составлен список заинтересованных сторон, участвующих в приоритизации, аннотированный их уровнем полномочий и влияния.

Ряд методов и рекомендаций, изложенных в Своде знаний по бизнес-анализу (BABOK® Guide), применены для нахождения приоритетов требований на примере условного коммерческого банка. Определены бизнес-потребности организации. Сформулированы основные проблемы процесса управления коммуникациями. Основополагающие источники проблемы проиллюстрированы на диаграмме «fishbone» (также известной как диаграмма причинно-следственных связей Исикавы). Составлен список заинтересованных сторон и их требований. Методика MoSCoW была применена для того, чтобы определить четыре группы требований, которые отличаются друг от друга воздействием результатов их реализации на решение выявленных проблем.

Приоритеты требований должны быть использованы на различных этапах проекта, что может быть полезно для менеджера проекта при планировании работ по внедрению решения. Результаты данной работы также должны помочь заинтересованным сторонам разработать общую точку зрения на стратегические цели проекта.

**Ключевые слова:** требования, приоритизация требований, диаграмма Исикавы, методика MoSCoW.

**Цитирование:** Kravchenko T.K., Bruskin S.N. Prioritization of requirements for effective support of the communication process with customers of a commercial bank // *Business Informatics*. 2017. No. 2 (40). P. 7–16.  
DOI: 10.17323/1998-0663.2017.2.7.16.

### Литература

1. A Guide to the Business Analysis Body of Knowledge ® (BABOK® Guide). Version 2.0. Toronto: International Institute of Business Analysis, 2009.
2. A Guide to the Business Analysis Body of Knowledge® (BABOK® Guide). Version 3. Toronto: International Institute of Business Analysis, 2015.
3. Agile extension to the BABOK Guide. Toronto: International Institute of Business Analysis, 2013.
4. Berander P., Andrews A. Requirements prioritization // *Engineering and managing software requirements* / Eds. A. Aurum, C. Wohlin. Berlin, Heidelberg: Springer, 2005. P. 69–94.
5. Karlsson J., Ryan K. A cost-value approach for prioritizing requirements // *IEEE Software*. 1997. No. 14 (5). P. 67–74.
6. Lehtola L., Kauppinen M., Kujala S. Requirements prioritization challenges in practice // *Proceedings of the 5th International Conference “Product Focused Software Process Improvement” (PROFES 2004)*. Kansai Science City, Japan. 5–8 April 2004. Berlin, Heidelberg: Springer, 2004. P. 497–508.



# Strategic management in the IT department

**Alexander N. Biryukov**

Associate Professor, Department of Business Informatics  
Financial University under the Government of the Russian Federation  
Address: 49, Leningradskiy Prospect, Moscow, 125993, Russian Federation  
E-mail: anbiryukov@fa.ru

## Abstract

This paper describes a new approach to strategic management in IT departments as compared with the existing approach, traditionally based on the development of an IT strategy aligned with the enterprise's business strategy. The proposed method assumes gaining greater trust from the business to be the principal goal of an IT department. Meanwhile, all the other goals are treated as implications of the trust, because none of them can be achieved if the IT department is not considered a trusted partner by the business management. Trust in the IT department is an aggregate of individual trust exhibited by its customers, some of which are interrelated and mutually affect their opinions. To obtain maximal personal trust, the IT department should apply an individual approach to each of its customers. In terms of IT Service Management (ITSM), this means that an individual Service Level Agreement (SLA) should be designed and used with respect to each customer. As a result, the IT Department will be able to gain the maximal integral trust. The IT Department can benefit from the acquired trust for different purposes. For example, the IT Department can use the increasing customer trust to justify modifications of SLA conditions so as to reduce IT costs without affecting the customer. Another way is using the integral trust to guarantee support of the corporate management when the IT Department starts some innovative undertaking in its own field. In the conclusion, it is shown that the problem of maximizing integral trust is not easier than the well-known knapsack problem.

**Key words:** IT department, IT strategy, business strategy, trust, Service Level Agreement (SLA), knapsack problem.

**Citation:** Biryukov A.N. (2017) Strategic management in the IT department. *Business Informatics*, no. 2 (40), pp. 17–24. DOI: 10.17323/1998-0663.2017.2.17.24.

## Introduction

The traditional approach to the strategic management of the organization's IT department is based on the concept of an IT strategy aligned with the business strategy of the enterprise. This concept forms the basis of the most known IT management methodologies and frameworks [1, 3] and standards describing the best IT management practices (for example, [2]). A detailed comparative analysis of various implementations of this concept can be found in [4].

Being highly consistent and reasonable this approach is not widely used (at least in Russia), although the majority of practitioners agree with its basic ideas. This contradiction is sometimes explained by immaturity of the Russian IT management practice, low qualifications

of CIOs and business management, and many other human-specific reasons. However, the actual reason appears to be much deeper and is impersonal by its nature.

The very concept of IT strategy is based on the following assumptions [1]:

- ◆ all enterprises must have a business strategy;
- ◆ structural units of the enterprise (such as the IT department) must have their own strategies resulting from the business strategy of the enterprise.

It is worth noticing that both of the above statements are only theoretical hypotheses that have no precise justification. This article does not discuss the causes for these hypotheses to occur and survive (those who are interested can refer to [5], for example), but describes an alternative approach to practical strategic

IT management that does not require the existence of business and IT strategies. This approach conceptualises the common practices of strategic IT management successfully used by many Russian enterprises and organizations, not only in the small and medium business segment.

### 1. Trust-based interaction of the IT department and the business

The modern look on the IT department as a cost center leads to the fact that the only set of measures proposed for the evaluation of its activities is that describing the costs. Therefore, IT cost savings become the only universal goal of the IT management. In this connection, two problems turn up. Firstly, the decision on large-scale IT investments and costs is often made by the top management, while the opinion of the IT department is not taken into account. The situation with the implementation of a corporate ERP solution can be used as an example. The IT department is essentially has no choice and is forced to take responsibility for future work within the IT budget which is not completed by the time. Secondly, even during stable periods focus on continual cost reduction interferes with the development of the IT department. In particular, it puts the IT department in an unfavorable position as compared with other participants of the labor market, leads to a loss of qualified personnel, unnecessary investment savings in staff development. Thirdly, local savings in the technical area do not always lead to global savings within the IT infrastructure of the entire organization.

A universal solution to these problems is to develop an IT strategy which is aligned with the business strategy so that a balance is reached between IT benefits and costs that would completely satisfy business customers of IT services. Unfortunately, even when the business strategy does exist (which is not always the case), this is very specific case that one can manage to assess the benefits of these or those IT solutions for the business as a whole. Therefore, the purpose of the IT department in the IT strategy is normally considered to reduce the costs, while responsibility for assessing the benefits of using IT and, consequently, determining the acceptable level of these costs is accepted by business management having no intimate knowledge in this area.

There are other problems associated with the idea of IT strategy. Among these are specifically:

- ◆ nonexistence of a straightforward method for synchronizing business and IT strategies (for example, [3] proposes to build IT goals, assuming their achievement

will contribute to the achievement of business goals, although it is clear that this is not a solution, but simply another formulation of the problem);

- ◆ the complexity of synchronizing changes in both strategies, which requires a very sophisticated practice of organizational change management to exist;

- ◆ a complicated mechanism of assessing the impact of changes in the IT on business results and vice versa.

Finally, the business strategy like any corporate decision always represents a complicated compromise of interests and influences of the top managers of the organization. This means that any serious IT decision that can affect the approved business strategy (for example, unplanned additional costs required to solve a serious IT problem encountered) are less possible to have been approved for purely technical reasons due to lots of negotiations and communications which have to be made, new budget decisions which may appear to be necessary, etc. Normally, top managers simply have no time for this, and the budgetary policy does not always allow for prompt changes to the budget. Therefore, such decisions are taken as appropriate without changing the strategies, which devalues these strategies making them formal documents no more reflecting the current reality.

This important conclusion of the above is that to make the process of negotiating and coordinating the strategy changes fast and efficient, the IT department must have a high credit of trust from the business. With a high level of trust, the IT department is delegated with all decision-making rights in this area. As a result, the IT strategy becomes an internal and non-public document which only concerns IT-department and doesn't restrict it anyhow. This dramatically simplifies the corporate decision-making process in the IT area. Thus, not following the language of the formal document, but a constant drive to boost business trust is the essence of the IT department strategy.

It is possible to draw (of course, a very superficial) an analogy between the trust earned by the IT department and the profit of an IT company working on the external market. Trust, like the profit, can be invested in growth, lost as a result of an incorrect risk assessment, or increased by abandoning external borrowings. The latter may be interpreted as the commitment of the IT-department to do work with not enough or obviously insufficient resources.

A general definition of trust is unlikely to exist. Much depends on the policies and traditions of a particular enterprise and personal attributes of the people. Neverthe-

less, it is possible to define some common symptoms of trust. Some people say that the level of trust earned by the IT department increases if:

- ◆ the actions of the IT department can be predicted and understood by its customers (both in the positive and negative aspects);
- ◆ the IT department makes every effort to solve the customer's problems;
- ◆ the IT department is always ready to help the customer, even at its own expense, i.e. by performing unanticipated work;
- ◆ the quality of work of performed by the IT department is at an acceptable (though not necessarily the highest possible) level.

As a consequence, the process of interaction between the customers and the IT department is simplifying (in particular, customers may no more require documentary evidence of the works performed by the IT department), decision-making in the IT area is accelerating (for example, by simplifying the document management), the IT department's susceptibility to innovations is increasing, etc.

The most common factor of the level of trust earned by the IT department may be the level of commercial risk resulting from the amount of responsibility in the IT management area delegated from business management. For example, the risk of unreasonable costs (including corruption costs) arises on developing the list of external contractors of a complicated IT project or IT program. The risk of loss in income arises from the use of highly innovative IT solutions in the organization products and services. In both cases not only the IT department but also the business is interested in building trust in the IT department.

It is significant that trust is not just limited to trust in the qualifications or knowledge of the IT department, but in all its characteristics affecting the business risk.

The exact equivalent of trust for the IT company does not exist, although in some aspects trust is similar to the market reputation or the company brand. The important part of the corporate IT policy is to determine what trust in the IT department depends on.

### 2. The IT department and its customers

The most common approach considers the enterprise as a whole or "business" to be the counterpart of the IT department. With respect to trust, this level of generality is not very productive. Of course, trust in the IT depart-

ment is composed of the trust of individual employees of the enterprise, but no process of averaging such trust exists in reality, as there is no document which would define this average trust. Even if there is a business strategy which is an agreed document, it normally has nothing to do with trust in the IT department.

The common point of view on the IT department's activity is that it is a provider of IT services for the enterprise. This very productive point of view was first explicitly formulated in the early publications of the IT Infrastructure Library (ITIL) [1] and evolved further for example, in standard [6] and procedure IT4IT proposed by the Open Group ([www.opengroup.org/IT4IT](http://www.opengroup.org/IT4IT)).

However, neither ITIL nor IT4IT provides answers to a number of questions concerning the activities of the IT department, for example:

- ◆ Who are the customers of the IT department?
- ◆ Are all customers equally important for the IT department?
- ◆ How is the IT department and customer interaction implemented?
- ◆ Who are the competitors of the IT department?

Therefore, it's necessary to define more precisely how do the IT-services look like. Normally, only the most general answer is given to this question (for example, in [1]), that does not imply any practical consequences as for the trust resulting from the activities related to services. It appears to be useful to look at the types of customers and sets of services provided to them by the IT-department. *Table 1* shows the principal types of customers of the IT department and the services provided to them.

*Table 1.*

**Customers and services of an IT department**

Customer groups	Services
Participants of business processes (users of information systems)	Facilitating the working conditions, automating routine operations
Business processes owners (middle management)	Increasing the efficiency (and also reliability, fault tolerance, flexibility, etc.) of business processes
Top management	Optimizing corporate IT costs, defining automation goals, managing corporate data, providing consulting services
Investors and business owners	Protecting IT investments, reducing IT risks, performing IT industry expertise

We have to emphasize that ordinary users of information systems, are classified as customers, although they obviously do not “pay for” IT department services. However, from the point of view of trust, the role of users is very high: it is the most numerous category of customers of the IT department services, which deals with it almost permanently, and largely affect a corporate perception of how the IT department works. For the enterprise owners *Table 2* shows only one option for their interaction with the IT department. In practice, this interaction is much more complicated, since much depends on the ownership structure and the objectives of investors. Therefore the set of services listed in the table should be considered only as an example.

Below are some examples of services for different categories of customers:

- ◆ facilitation of working conditions (for the users):
  - perform input data checks thus preventing of input errors;
  - effectively assist in case of difficulties in information systems handling;
  - accurately determinate the responsibility of each business process participant in any situation and conflict resolution among the participants;
  - provide comfortable psychological working conditions, including, for example, mitigation of the impact of the mistakes on the work results of other participants;
- ◆ increase the efficiency of business processes (for their owners):
  - enhance business process characteristics without placing an additional responsibility on their owners;
  - ensure a permanent participation in execution of the business processes throughout their life cycles, including the development and reengineering of the processes; constant responsibility for functionality of the process automation tools;
  - provide a strict division of responsibility for the results of the work of business processes between their owners and the IT department;
  - provide a mutually comfortable level of interaction of the IT department with the business-process owners;
- ◆ cost saving, corporate data management, consultation services (for top management):
  - provide consultations and expert services associated with consideration of feasibility and expediency of automation of any given business processes;

- perform master data management;
- ensure IT cost optimization;
- participate in the development of IT budget;
- increase the level of management qualifications in the IT area.
- ◆ IT investment protection, industry expertise (for investors and owners):
  - select and use, if possible, well-proven IT solutions and reliable suppliers of solutions and services;
  - provide expert opinions on IT solutions dominating the market, their reliability, associated risks, etc., providing information on new trends in the IT area and their prospects at the enterprises;
  - inform about IT-related threats and capabilities of the external environment.

We emphasize the fundamental difference between the IT department and an IT company operating in the common market: the IT department is not allowed to choose its customers; it cannot abandon the existing customer or service demand from a new customer. On the other hand, the customer cannot apply for IT services to anyone except the IT department.

The above examples do not provide a comprehensive look at the services of an IT department, but demonstrate some important points for the rest of the paper. Firstly, the services provided to different groups of customers differ significantly and virtually do not overlap. At the same time, customer satisfaction with services depends not only on services rendered directly to them, but also on services rendered to their subordinate employees. Thus, the business process owner cannot ignore the opinion of his employees when assessing the service quality to improve the effectiveness of this business process. Secondly, the reality is that services do not compensate for each other. For example, there are known cases when the owner simply ignores the opinion of the IT department when choosing a corporate IT solution, notwithstanding the fact that all owners of business processes and top management are completely satisfied with the services rendered to them. On the other hand, there are examples of IT departments that are in good standing with top management and ignore the requests of some business process owners. Thirdly, not all services are available in the IT department portfolio. This depends not only on historical reasons, but also on the sourcing strategy adopted in the IT department.

The value chain of the IT department can be outlined as shown in *Figure 1*.

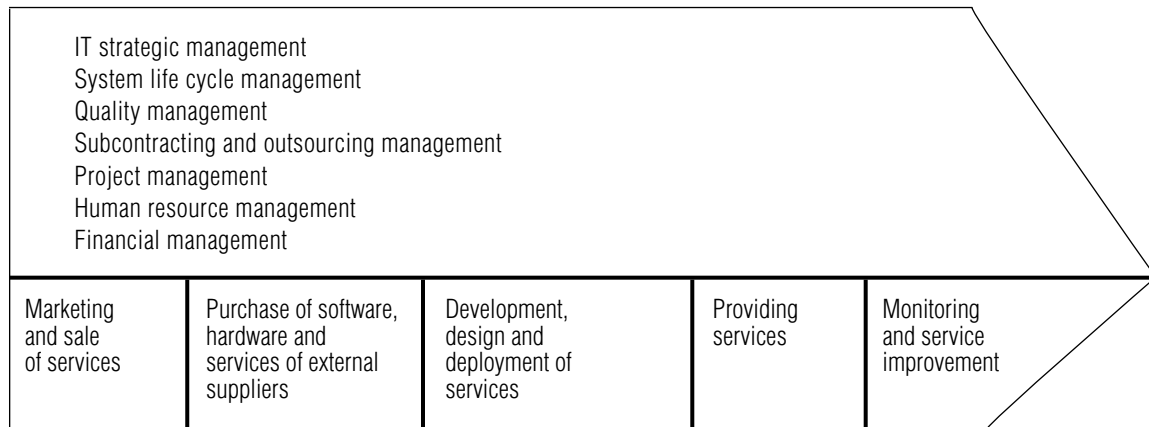

*Fig. 1. Value chain of the IT department*

The lower part of the chain depicts basic processes, and the upper part depicts secondary processes. The human resource management and financial management processes are the same as the appropriate enterprise processes. The basic processes are to a greater extent specific for each IT department. The secondary processes, vice versa, are rather multipurpose: a large variety of process models reflecting the best management practices exists for them.

The trust of one customer is not automatically converted into the trust of another, although the trust of both can definitely interact. Thus, the trust of the management approving the IT budget minimization by the IT department may result in mistrust of the IS users facing an increase of the service time and apparent disregard for their interests. There is also a reverse effect: distrust of subordinate employees of a particular business process owner may undermine their loyalty to the IT department and the owner himself; the owner's distrust will influence the trust of the management, etc.

We should also mention the format of the relationship between the IT department and the customers. ITIL version 2011 [1] does not insist on a rigid contract form of the Service Level Agreement (SLA) for managing the IT department's relationship with customers. ITIL also notes that the formal monitoring of the service level does not always allow us to estimate the perception of the service by the customer, who can demonstrate positive attitude in spite of low level of service or, conversely, a negative attitude even though the target levels of the service have been formally achieved. Thus, the meaning of SLA is more likely to achieve closer and more stable (and therefore, more trust-based) relations between the IT department and its customers, as compared to the description of formal service quality criteria.

From the point of view of the SLA format, an agreement on strategic partnership with the customer seems to be the most appropriate one. For each customer of the IT department, such an agreement will be its own, and the customer's trust will be determined not only (and not so much) by the service level, but by the confidence that the IT department has done its utmost to provide the highest-quality service.

The result of the strategic partnership is generally not to gain benefit from the market exchange between the partners, but to gain the benefits from the third party, in this case, the business customers. It is partnership relations where trust plays a key role being the most important factor the relationships depend on.

### **3. A trust management model for the IT department**

Based on the assumption that the main goal of the IT department is to build trust, it is possible to build a strategic map of R. Kaplan and D. Norton for it, which includes a perspective of trust. The important point is that the perspective of trust merges two classical perspectives, namely, the results-based (financial) perspective and the perspective associated with customer satisfaction. Here it is necessary to emphasize that the perspective of trust is not identical to the perspective of customer satisfaction. There can be cases when the customer is not satisfied with the service, but trusts the IT department, believing that in the present conditions the department has done its best. Conversely, the customer can be completely satisfied with the service, but sure that it is not the merit of the IT department, since the service was provided by an external supplier.

The building of trust should be accompanied by a transition SLA to a new format which extends the IT depart-

Table 2.

Strategic map of an IT department

Perspectives	Customer groups			
	Participants of processes	Owners of processes	Management	Owners
Trust	Agreement with a participant (group of participants), implying an increase in trust	Agreements with the owners, implying an increase in trust	Agreement with the management, implying an increase in trust	Agreement with the owner, implying an increase in trust
Internal processes	The objectives in terms of providing services to process participants	The objectives in terms of providing services to process owners	The objectives in terms of providing services to the management	The objectives in terms of providing services to the owners
Development	The objectives that characterize the development of services for process participants	The objectives that characterize the development of services for process owners	The objectives that characterize the development of services for the management	The objectives that characterize the development of services for the owners

ment’s authority in providing services to the customer. For example, a new SLA may allow the IT department to modify a service without a preliminary consulting with the customer, or assign a high priority to certain internal IT department projects while reducing it for customer services.

Which SLA parameters are the most desirable to be changed for the IT department at the moment depends on a variety of reasons. As an example, below we consider the parameters that enable the IT department, to save resources when providing service to a customer due to the increased trust (here, the resources are considered to be IT personnel labor costs expressed in man-hours). Other parameters or combinations of such parameters may also be of interest. This particular case demonstrates only one of a variety of aspects of strategic IT department management.

It is obvious that not all customers are equally important for the IT department in terms of their contribution to the overall trust in it. For example, the trust of the manager is more important than the trust of an ordinary participant of the business process. Therefore, a weight can be assigned to every customer to enforce his trust when calculating the overall trust gained by the IT department.

Therefore, the IT department should set up and solve a complicated optimization problem of maximizing the overall trust of all customers provided it has a limited amount of IT resources. The aim of the IT department in this situation is to optimize the resource management. Having realized the overall trust the IT department may release resources for its further activities. Here are some examples of such situations:

- ◆ mutual abandonment of the development of formal system specifications for some customers will result in savings of business analyst resources which can be used in other projects. Here, a amount of work necessary to develop the technical specification serves as an important parameter of the agreement;

- ◆ mutual abandonment of a formal tender documentation agreed upon with the IT department customer demonstrates trust in the IT department as an impartial trading authority. An important parameter here is the amount of work for preparing and coordinating the tender documentation;

- ◆ mutual abandonment of a part of project documentation (for example, detailed work breakdown structures, detailed project schedules, etc.) allowing the savings of resources involved in the project management processes. An important parameter is the amount of work on project management.

This informal approach to trust management is refined and formalized below. As a result, a trust management model for the IT department is built. The model is designed under the following assumptions:

- ◆ the IT department has got  $N$  customers;
- ◆ each customer is assigned the weight  $p_i, i = 1, 2, \dots, N$ , reflecting the customer’s contribution to the overall level of trust in the IT department;
- ◆ the  $i$ -th customer has got a finite number  $V_i$  of possible options of service level agreement (SLA)  $s_{i1}, s_{i2}, \dots, s_{iV_i}$  (each option covers all services provided to this customer).
- ◆ only one Service Level Agreement can be made with each customer. The selection of the agreement option is

defined by variable  $x_{ij} \in \{0, 1\}$  ( $x_{ij} = 1$ , if  $j$ -th agreement option is applied to  $i$ -th customer, otherwise  $x_{ij} = 0$ );

◆ various agreement options provide for various scopes of using resources by the IT department  $r_{i1}, r_{i2}, \dots, r_{iV_i}$  (with the current trust level);

◆ various agreement options vary in the degree of their impact on the level of trust in the IT department on the part of this customer: the more resources the IT department spends on this customer, the more prerequisites exist in the future to increase the level of trust;

◆ all resources of the IT department used for providing services to the customers are considered to be interchangeable. The total amount of resources is limited by the value  $R$ .

In this case, the task of optimizing the distribution of IT department resources among its customers in order to increase the overall level of trust in the IT department is similar to the well-known knapsack problem and is as follows:

$$\begin{aligned} & \max \sum_{i=1}^N p_i \sum_{j=1}^{V_i} r_{ij} x_{ij}; \\ & \sum_{j=1}^{V_i} x_{ij} = 1, \quad i = 1, 2, \dots, N; \\ & \sum_{i=1}^N \sum_{j=1}^{V_i} r_{ij} \leq R. \end{aligned}$$

Once again, we note that in this problem the amount of resources needed to implement any service level agreement is determined for the current level of trust in the IT department. In the long term, with the trust being built, these costs may decrease (and vice versa, if the trust level is reduced, the costs increase).

There are cases when an important parameter of the agreement with the customer is not the amount of work or other numerical parameter, but some qualitative characteristic. For example, let us have an SLA

providing for a passive participation of the IT department in a discussion on business plans and tasks. The organization management can offer the IT department to provide, by a certain period of time, its own detailed justifications and recommendations regarding the timing and ways of automating certain business processes, as well as choosing the processes themselves. Such an agreement demonstrates higher trust in the IT department and also requires more resources to provide the service. In this and similar cases, it is possible to evaluate, for example, an increase of the IT budget if the IT department proposals are accepted, growth of the number of IT employees, increased influence of the IT department in interaction with other customers, etc.

It is hardly possible to accurately define a general set of capabilities associated with increasing trust in the IT department, and methods for their numerical evaluation. The above model of trust management can be useful, since it demonstrates that the problem can be effectively solved in many practical cases.

### Conclusion

This article proposes a new approach to strategic management in the IT department, based not on the commonly recognized alignment between the business and IT strategy, but on the use of the trust concept as a universal target for the IT department. The trust is considered to be tightly closed with a level of risk for the organization arising from the delegation of the additional authority to the IT department. The principal conclusion is that both the IT department and the business as a whole are interested in increasing the trust in the IT department. The above formal model of trust management enables IT department to optimize the distribution of its resources among its customers in order to increase the common trust in the IT department. ■

### References

1. The Stationary Office (2011) *ITIL V3 – Service Strategy*, 2011 edition. Best Management Practice. London, 2011.
2. ISO/IEC (2008) *Corporate governance of information technology*. International standard ISO/IEC 38500:2008.
3. ISACA (2012) *COBIT 5. A business framework for the governance and management of enterprise IT*. Rolling Meadows, IL: ISACA.
4. Zelenkov Yu.A. (2013) *Iskusstvo bega po grablyam. Strategicheskoe upravlenie IT v usloviyakh neopredelennosti* [Art of rake running. IT strategic management in the conditions of uncertainty]. Moscow: CROC (in Russian).
5. Rozin M. (2011) *Uspekhi bez strategii* [Success without strategy]. Moscow: Alpina Publisher (in Russian).
6. Standardinform (2014) *GOST R ISO/IEC 20000-1-2013. Informatsionnaya tekhnologiya. Upravlenie uslugami. Chast' 1. Trebovaniya k sisteme upravleniya uslugami* [ISO/IEC 20000-1-2013. Information technology. Service management. Part 1. Service management system requirements]. Moscow: Standardinform (in Russian).

## Стратегическое управление ИТ-службой

**А.Н. Бирюков**

*кандидат физико-математических наук, доцент кафедры бизнес-информатики*

*Финансовый университет при Правительстве РФ*

*Адрес: 125993, г. Москва, Ленинградский пр-т, д. 49*

*E-mail: anbirukov@fa.ru*

### Аннотация

В статье описывается новый подход к стратегическому управлению ИТ-службой организации, в сравнении с существующим подходом, который обычно основывается на разработке ИТ-стратегии, соответствующей бизнес-стратегии организации. В предложенном методе единственной принципиальной целью ИТ-службы считается достижение высокого уровня доверия к ней со стороны бизнеса. При этом остальные цели являются производными этого доверия, поскольку ни одна из них не будет достигнута, если бизнес-руководство не относится к ИТ-службе как к надежному партнеру. Доверие к ИТ-службе представляет собой комбинацию доверия со стороны отдельных клиентов, взаимосвязанных и влияющих на мнения друг друга. Для того, чтобы максимизировать доверие со стороны отдельных клиентов, ИТ-служба должна придерживаться индивидуального подхода к каждому из них. С точки зрения управления ИТ-услугами (IT Service Management, ITSM) это означает, что нужно разрабатывать и использовать индивидуальные соглашения об уровне услуг (Service Level Agreement, SLA) с каждым клиентом. В результате будет обеспечено высокое суммарное доверие к ИТ-службе. Доверие можно использовать для разных целей. Например, ИТ-служба может использовать возросшее доверие клиента для модификации условий SLA с этим клиентом, чтобы снизить собственные издержки, не затрагивая интересов клиента. Другой вариант – использование суммарного доверия для обеспечения поддержки менеджментом организации инновационных работ в области ИТ. В заключение показано, что задача максимизации общего доверия не проще, чем хорошо известная задача о рюкзаке.

**Ключевые слова:** ИТ-служба, ИТ-стратегия, бизнес-стратегия, доверие, соглашение об уровне услуг, задача о рюкзаке.

**Цитирование:** Biryukov A.N. Strategic management in the IT department // Business Informatics. 2017. No. 2 (40). P. 17–24. DOI: 10.17323/1998-0663.2017.2.17.24.

### Литература

1. ITIL V3 – Service Strategy, 2011 edition // Best Management Practice. London: The Stationary Office, 2011.
2. Corporate governance of information technology. International standard ISO/IEC 38500:2008. ISO/IEC, 2008.
3. COBIT 5. A business framework for the governance and management of enterprise IT. Rolling Meadows, IL: ISACA, 2012.
4. Зеленков Ю.А. Искусство бега по граблям. Стратегическое управление ИТ в условиях неопределенности. М.: КРОК, 2013.
5. Розин М. Успех без стратегии. М.: Альпина Паблишер, 2011.
6. ГОСТ Р ИСО/МЭК 20000-1-2013. Информационная технология. Управление услугами. Часть 1. Требования к системе управления услугами. М.: Стандартинформ, 2014.



# Information efficiency, information design and information system of an organization

**Yuri A. Zelenkov**

*Adviser to the Chief Designer  
NPO Saturn*

*Address: 163, Lenin Ave., Rybinsk, Yaroslavl Region, 152903, Russian Federation  
E-mail: yuri.zelenkov@gmail.com*

## Abstract

This article proposes a methodology for analyzing an organization management system and selecting the most relevant strategy to enhance its information efficiency. Information efficiency is determined through the amount of information that is required to ensure the coordination and motivation processes. We discuss four organizational design strategies aimed at improving information efficiency. Two of them are associated with a reduction of the amount of information required for management: creation of buffers (stocks of raw materials, work in progress and surplus resources) and system decomposition into independent operating units. Two other strategies are aimed at increasing the organization capabilities to process information, i.e. develop information systems and create a context facilitating information exchange.

It is shown that the strategy of creating buffers leads to inefficiency, but it spontaneously occurs under conditions of the lack of information. The implementation of other strategies requires the organization's efforts. The policy of measuring the information efficiency of the organization is discussed, and since at present it is hardly possible to develop a single method, it is recommended that one use benchmarking.

Estimates of the information volumes which are being handled by high-technology machine-building enterprises in Russia and abroad are provided. It is demonstrated that due to underdevelopment of the technological infrastructure domestic enterprises are forced to process overly great amounts of data, which leads to information overload and, as a consequence, creation of buffers at all production stages. The result is an overall inefficiency of the enterprise as compared to similar foreign enterprises, and this gap cannot be overcome only by creation of enterprise information systems. In this regard, we present an example of production system decomposition which enables one to reduce the amounts of management information.

**Key words:** management efficiency, organizational design, manufacturing management system, manufacturing planning, ERP system.

**Citation:** Zelenkov Y.A. (2017) Information efficiency, information design and information system of an organization. *Business Informatics*, no. 2 (40), pp. 25–32. DOI: 10.17323/1998-0663.2017.2.25.32.

## Introduction

Modern information technologies (IT) allow us not only to improve existing practices, but also to create new business models that increase the organization's efficiency. A large number of studies has been devoted to the study of the IT effect on efficiency [1–4]. At the same time, many researchers note that the introduction of IT into organizations is

always connected not only with a change of information systems (IS) themselves, but also operational principles, user skills and other complementary resources [5], all of which increase the complexity of such projects. Investigation of the factors affecting the project success of implementing new IT systems is a very trendy topic [6], inasmuch as vast literature is devoted to the analysis of barriers and constraining factors [7, 8].

An assessment of the potential impact of new IT and identification of risks to achieve it are an essential component of strategic IT management, but the common methodology of making such decisions is not available. Most of the afore-mentioned papers have a descriptive character and empirical data, although generalized, is not converted into action norms and regulations.

This paper uses a methodological approach based on a combination of concepts of the organization's information efficiency [9] and information design [10]. In the first section, the theoretical aspects of both concepts are discussed, and in the subsequent sections the practical application of the proposed methodology is illustrated using the example of selecting a strategy of improving the information efficiency of the NPO Saturn manufacturing system (<http://www.npo-saturn.ru>).

### **1. Information efficiency and the information design of an organization**

According to paper [9], the main organizational functions are coordinating the efforts of all its participants in agreeing upon common goals and motivating compliance with the agreements reached. On this basis, an organization's information efficiency criterion (IEC) was proposed: an organization that requires less information to support coordination and motivation processes is more efficient [9]. This criterion can be used specifically while making decisions on the implementation of new IT initiatives; however, this causes a problem of its quantitative assessment. Most likely, it is not possible to develop a universal approach for measuring IEC, therefore, the most obvious and simple approach is benchmarking, namely comparing the amounts of information operated by different organizations performing closely related activities. An example of evaluation of the information efficiency of the manufacturing system of a high-technology machine building enterprise will be presented in the next section.

In addition, it is worth noting that the information efficiency of an organization can be enhanced not only through reduction of the amount of information needed for coordination and motivation, but also by increasing the organization's capability to process this information. This point of view is verified by results of empirical studies of the impact of IT investments on the company's productivity [11, 12], namely, introduction of new IT primarily reduces the labor costs of the employees involved in information processing, that eventually leads to reduction of transaction costs.

Paper [10] addresses general principles of organizational design through the lens of information efficiency, and two main types of strategy are distinguished: reduction of information required for management, and increase of the organization's capability to process it. The first type of strategies includes:

- ◆ compensation of uncertainty (i.e. lack of information) through creation of buffers (slack resources in term of [10]). This strategy is realized through increase of raw material stocks, increase of work in progress, emergence of excess capacity. It results in a decrease of economic efficiency. It is in contradiction with such modern concepts as "lean manufacturing" and "just in time", but is spontaneously formed at the enterprises suffering from information inefficiency;

- ◆ decomposition of the system into loosely coupled modules grouped around the same-type products or services. Such a module must have all necessary resources to provide the entire value chain, and after that it can be considered as a "black box" hiding internal information flows. This is today's mainstream in the organization of manufacturing systems [13], while outsourcing is a natural development of this area.

The strategy of increasing the information processing capabilities implies:

- ◆ development of enterprise information systems. It is worth noting that the term "information system" is used here not in the narrow sense (IT based system), but in the wider sense, like any system enabling us to collect, transmit, store and process information. In this regard, the accounting system, for example, is the information system;

- ◆ development of communications between the employees (direct contacts, introduction of special functions – integrators, working groups, matrix organization, etc.).

The organization can combine simultaneously all these strategies, but in each specific case it is necessary to analyze which strategy can make the greatest contribution to increasing information efficiency. The most obvious conclusion is that, generally speaking, the reduction of the amount of information in the coordination and motivation processes achieved by system decomposition is the more attractive way, since it is directly aimed at reducing transaction costs. However, such restructuring in most cases comes into conflict with accepted practices; it requires radical changes and always encounters a significant resistance [14, 15].

The strategies related to improving information processing capabilities should be applied when capabilities of reducing this information are either unavailable,

or for some reason are unrealizable. At the same time, preference is given to a strategy aimed at developing communications between employees, creating the context enabling us to propagate information [16] and, in a more comprehensive sense, enterprise knowledge [17].

The development of enterprise information systems, especially through the introduction of IT, is always associated with difficulties that have several sources. First, it requires changes not only in the information processing methods, but also in complementary resources, namely, user skills, IT infrastructure, and so on [5]. In this case, the complexity of IS implementation is connected with the area of its implementation [18]: it is minimal for systems aimed at reducing the transformational costs of an individual employee, and increases with the transition to coordination of activities of the organizational unit, the entire organization and, further, to management of interaction with external agents. In addition, the authors of paper [19] point out that the appearance of new technologies is a source of techno-stress for users. On the other hand, the users often try to use IS to solve problems which were not foreseen by its developers [20]. Finally, the IS implemented can become an obstacle to subsequent changes in the organization, since it provides for a limited set of business process execution options [21].

Creation of buffers, i.e. stocks of raw materials, work in process and excess capacity is an extreme case. This strategy should be resorted to when other capabilities cannot be implemented. However, there are situations, when the presence of a buffer is a prerequisite for successful operation. For example, the theory of constraints by E.M. Goldratt [22] provides for creation of buffers to the system bottlenecks, which determine its performance.

Thus, the introduction of new IT should be considered as a special case of a more general problem – organizational design strategy selection. The information efficiency criterion, assessing the amount of information in the coordination and motivation processes, is an effective tool for evaluating various options for organizational design solutions. This raises the problem of quantitative evaluation of this criterion. Since a unified methodology of such an assessment can hardly be developed, we propose to use the benchmarking technique to compare the amounts of information required for management in companies using close business models. The next sections will address the implementation of these proposals in practice.

## 2. Information efficiency of NPO Saturn manufacturing system

This section addresses practical experience of PJSC NPO Saturn, a Russian company engaged in the design, manufacture and aftersales service of aircraft gas turbine engines.<sup>1</sup> One of the key projects of NPO Saturn in the early 2000s was to develop the SaM146 engine for the regional Super Sukhoi Jet 100 aircraft in partnership with the French company Snecma<sup>2</sup> (these products were primarily oriented to the international market).

Partnership with the leading foreign manufacturers and claims to market entry with extremely high business competition revealed many problems of the Russian project participants. For example, by labor efficiency (revenue per employee), Snecma outperformed NPO Saturn by more than seven times. It became obvious that for the collective success of the project all its participants must ensure the same efficiency in terms of costs, labor efficiency and duration of the production cycles. As a consequence, NPO Saturn launched changes covering almost all areas of activity, i.e. retooling and modernization, implementation of new methods of organization of work and management, staff development, establishment of long-term stable relations with partners having necessary competencies, reduction of stocks, etc.

At the same time, an ERP system was proposed to be used as the main information processing tool. A rather advanced set of in-house designed IS supporting various tasks of manufacturing management existed at the enterprise. Nevertheless, it was expected that the ERP system would provide a significant head start due to switching to new “optimal” business processes purchased with the system. However, a number of pilot projects showed that the required efficiency cannot be achieved only by replacing the existing IS with ERP. Detailed analysis revealed that the main differences between the Russian and foreign enterprises of high-tech machine-building are in the field of information efficiency, rather than anywhere else, and it is these differences that prevent the implementation of the processes that are implemented in the ERP system. Let us consider these differences by the example of the manufacturing system.

From the information point of view, the main task of the manufacturing system is to form a feasible manufacturing plan, record the actions taken in accordance with

<sup>1</sup> In 2003–2008 the author of the article was responsible for IT-support of the SaM146 program on the Russian side, and in 2009–2014 he held the position of the IT director of PJSC NPO Saturn.

<sup>2</sup> At present Safran Aircraft Engines division of Safran group.

this plan, detect deviations and respond to them. All these activities are based on the data of the production facilities (product and its components) and resources (equipment, personnel, finance, etc.). The atomic unit of planning and accounting is the manufacturing operation, to which the equipment, tooling, time and material consumption rates, etc. are related. The more precise this data is, the more accurate the calculation of the manufacturing plan, which is a time schedule of a sequence of operations for manufacturing specific products at a given time.

It should be pointed out herewith that the manufacturing facilities of Russian companies are derived from the Soviet period and have not been radically updated yet at any of the large enterprises (the average age of the equipment is 20–25 years at the most). This means that on average a part is manufactured in a greater number of operations than in a similar foreign manufacturer. According to the author’s estimates, for similar process stages Russian machine builders need to perform 4–10 times more operations compared to their foreign counterparts. In addition, foreign enterprises which manufacture small-scale high-technology products, all alone manufacture only about 10–20% of the variety of all parts coming to the assembly line, with all the rest being obtained from second-tier suppliers, which, due to their specialization, provide much greater efficiency. Domestic enterprises produce almost 100% of the assembly parts themselves. A trade-off analysis of the amount of data needed to ensure the manufacturing planning and accounting operated by PJSC NPO Saturn and Snecma is shown in *Table 1*.

It follows from what has been said that with the same throughput capacity, the amount of data required for manufacturing management at a Russian enterprise is 20 times greater than at a foreign enterprise having a more efficient production infrastructure. This leads to low-quality plans, a huge amount of dispatching, unreliable and conflicting data on the actual situation with manufacturing of products. Therefore, most domestic enterprises use their in-house developed IS, which somehow enable them to handle unreliable information.

An additional problem is obtaining accurate data on the configuration of the manufactured product. The configuration in this case is taken to mean a description of all units, parts and purchased components forming bill of materials (BOM) of the final product. Low-batch production is characterized by a continuous change of BOM, since the product design is constantly refined either by the operation results, or the requirements of a particular customer. The problem for domestic enterprises is that this process is not completely automated anywhere and, moreover, the existing regulatory structure allows for several types of documents changing the product configuration (engineering change orders, assembling specifications, etc.), each of which has its own peculiarities. Therefore, the configuration is defined manually on the basis of paper documents, which leads to errors. At the same time, the study of the best practices of foreign enterprises shows that with the information systems available it is possible to provide a configuration management process based on only one document – an engineering change order.

The impacts of unreliability of information on the product configuration and manufacturing operations on the quality of the manufacturing plan were investigated in paper [23]. The results obtained in this paper are provided in *Figure 1*, where curve 1 represents the impact of errors in determination of the operation execution time; curve 2 represents errors in assignment of work centers, and curve 3 represents errors in definition of the product configuration.

Analysis of this data shows that even if there is an error in determining the execution time for each tenth manufacturing operation, 65% of manufacturing orders are assigned incorrectly. The share of errors in the manufacturing plan reaches its maximum value of 92% in incorrect determination of the execution time for 45% of operations. However, it is worth noting that in this case the share of errors in the plan never reaches 100%, since the assignment of the first operation in the manufacturing routing is always performed correctly.

*Table 1.*

**Volumes of information required for manufacturing planning**

	<b>Snecma</b>	<b>NPO Saturn</b>
Variety of parts for assembly (pcs.)	36,000	36,000
Number of parts of in-house production	6,000	30,000
Average number of operations to manufacture a part	20	80
Number of information objects (operations), the correctness of which must be maintained	120,000	2,400,000
Number of employees responsible for entry of information	100	400
Number of information objects per one employee	1,200	6,000

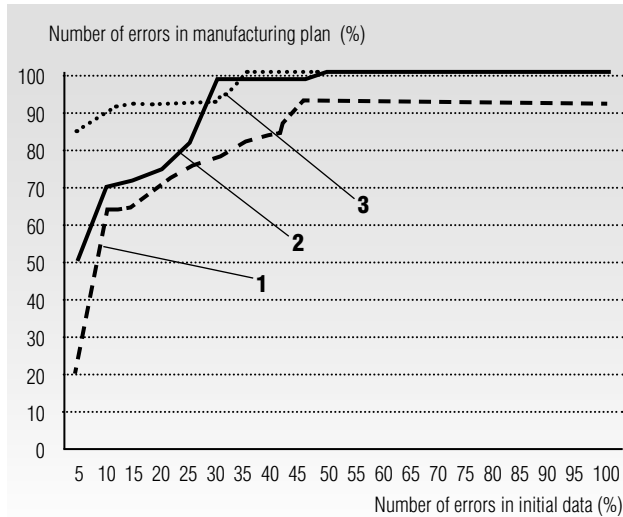

Fig. 1. The impact of initial data errors on the accuracy of manufacturing planning

With errors in determining the work centers (curve 2), the number of misdirected work assignments increases more intensively and reaches 100% already at a 30% level of unreliability of the initial data. The influence curve 3 shows that even a negligible level of errors in the configuration data of the product leads to almost complete unreliability of the manufacturing plan. Therefore, the manufacturing system is non-linear, and minor errors in the initial data lead to significant errors in decision making (planning).

From the data presented, it follows that there is an unambiguous cause and effect relationship: imperfect technical and management infrastructure – the amount of information for management – the management system quality. Imperfection of the technological infrastructure leads to a sharp increase in the volume of manufacturing operations. Insufficient maturity of business processes, such as configuration management, leads to unreliable data on the product BOM, that affects on the planning quality are even more unfortunate (it should be noted that, contrary to technological processes, the amount of configuration data for similar products is approximately the same for Russian and foreign enterprises). The infrastructure problems cause an information overload of the management system. The enterprise responds to this overload by creating buffers from raw materials and purchased parts, work in progress and excess capacity, and all of that eventually leads to a sharp drop of its efficiency. It is obvious that this problem is extremely difficult to fix through introduction of an information system based on IT or any other data collection and processing principles.

It is necessary to involve other organizational design strategies.

### 3. Decomposition of manufacturing system

Analysis of the information processed by NPO Saturn (*Table 1*) shows that the volume is a critical constraining factor in terms of efficiency. Alternatively, according to the logic outlined in Section 1, the idea of decomposing the manufacturing system into loosely coupled modules organized around the same parts was put forward. This proposal encountered a sharp negative reaction, especially on the side of representatives of the manufacturing system, which confirmed that the existing structure of workshops and groups was bound by complex connections which impeded the transformation. Historically, the equipment necessary for processing parts of the same type is located on the territory of different workshops.

The possibility of the proposed decomposition was verified by cluster analysis using the *k*-means method. The results were presented in a table, where rows list key parts of the aircraft engine, and columns list manufacturing groups, while the filled cells at the intersection of the row and the column indicate that the parts of this type are processed in this group. It was revealed that the NPO Saturn manufacturing system is divided into several clusters, each of which provides a full cycle of operations for manufacture of a certain type of parts; in this case, a significant intersection between the clusters is practically absent. We have to note that such clustering, as expected, does not comply with the established structure of workshops.

Based on these studies, NPO Saturn top management decided to divide the manufacturing into independent divisions which are to manufacture a narrow range of similar products (rotating parts, hull elements, rotating blades, etc.). Each of these divisions receives orders from product directorates (civil engines, military engines, industrial plants), the structure of which includes assembly lines and divisions interacting with the consumers. The activities of each division are assessed by economic indicators. This decision made it possible to reduce a total amount of information needed to coordinate the manufacturing system of the whole enterprise. The first tangible result of such transformation was an increase of the share of production orders executed when required. In the course of time, other effects of reducing the information flows have become apparent, in particular, such functions

as bottleneck analysis, assessment of investment needs for development, unification of technical processes for similar parts, “make or buy” analysis. Outsourcing development began to demand much less effort.

It is worth noting that it was possible to achieve these results without modernizing the enterprise IS, just by reducing information flows and, consequently, increasing the information efficiency. Implementation of the ERP system supporting optimized single-type processes is the next step after stabilization of the new manufacturing structure. This should give greater freedom to information processing in the newly established divisions.

## Conclusion

Enterprises trying to improve economic performances must first investigate the potential of various strategies to increase the information efficiency. In this case, it is preferable to avoid strategies of creating resource buffers. NPO Saturn experience shows that the greatest effect in such conditions reduces information flows through system decomposition, which can be accompanied by an increase of the company’s ability to process information through development of enterprise IS and communications between the employees. ■

## References

1. Kohli R., Grover V. (2008) Business value of IT: An essay on expanding research directions to keep up with the times. *Journal of the Association for Information Systems*, vol. 9, no. 1, pp. 23–39.
2. Mithas S., Ramasubbu N., Sambamurthy V. (2011) How information management capability influences firm performance. *MIS Quarterly*, vol. 35, no. 1, pp. 237–256.
3. Saunders A., Brynjolfsson E. (2016) Valuing information technology related intangible assets. *MIS Quarterly*, vol. 40, no. 1, pp. 83–110.
4. Tambe P., Hitt L.M. (2012) The productivity of information technology investments: New evidence from IT labor data. *Information Systems Research*, vol. 23, no. 3, part 1, pp. 599–617.
5. Brynjolfsson E., Milgrom P. (2013) Complementarity in organizations. *The handbook of organizational economics* (eds. R. Gibbons, J. Roberts). Princeton: Princeton University Press, pp. 11–55.
6. Shaul L. Tauber D. (2013) Critical success factors in enterprise resource planning systems: Review of the last decade. *ACM Computing Surveys (CSUR)*, vol. 45, no. 4, pp. 55–55:39.
7. Rivard S., Lapointe L. (2012) Information technology implementers’ responses to user resistance: Nature and effects. *MIS Quarterly*, vol. 36, no. 3, pp. 897–920.
8. Taylor H., Artman E., Woelfer J.P. (2012) Information technology project risk management: Bridging the gap between research and practice. *Journal of Information Technology*, vol. 27, no. 1, pp. 17–34.
9. Milgrom P., Roberts J. (1992) *Economics, organization and management*. London: Prentice-Hall.
10. Galbraith J.R. (1984) Organizational design: An information processing view. *Army Organizational Effectiveness Journal*, vol. 8, no. 1, pp. 21–26.
11. Brynjolfsson E., Hitt L. (2003) Computing productivity: Firm-level evidence. *Review of Economics and Statistics*, vol. 85, no. 4, pp. 793–808.
12. Brynjolfsson E., Saunders A. (2010) *Wired for innovation: How information technology is reshaping the economy*. Cambridge: MIT Press.
13. Hopp W.J., Spearman M.L. (2011) *Factory physics*. Long Grove, IL: Waveland Press.
14. Lozano R. (2013) Are companies planning their organisational changes for corporate sustainability? An analysis of three case studies on resistance to change and their strategies to overcome it. *Corporate Social Responsibility and Environmental Management*, vol. 20, no. 5, pp. 275–295.
15. Jacobs G., Van Witteloostuijn A., Christe-Zeyse J. (2013) A theoretical framework of organizational change. *Journal of Organizational Change Management*, vol. 26, no. 5, pp. 772–792.
16. Nonaka I., Toyama R., Hirata T. (2008) *Managing flow: A process theory of the knowledge-based firm*. NY: Palgrave Macmillan.
17. Nahapiet J., Ghoshal S. (1998) Social capital, intellectual capital and the organizational advantage. *Academy of Management Review*, vol. 23, no. 2, pp. 242–266.
18. Zelenkov Y. (2014) Components of enterprise IT strategy: decision-making model and efficiency measurement. *International Journal of Information Systems and Change Management*, vol. 7, no. 2, pp. 150–166.
19. Tarafdar M., Pullins E.B., Ragu-Nathan T.S. (2015) Technostress: negative effect on performance and possible mitigations. *Information Systems Journal*, vol. 25, no. 2, pp. 103–132.
20. Ciborra C. (2002) *The labyrinths of information: Challenging the wisdom of system*. NY: Oxford University Press.
21. Zelenkov Y. (2015) Business and IT alignment in turbulent business environment. *Lecture Notes in Business Information Processing*, no. 228, pp. 101–112.
22. Goldratt E.M., Cox J. (2004) *The goal: A process of ongoing improvement*. 3rd ed. Great Barrington, MA: The North River Press.
23. Zelenkov Y. (2015) Ob effektivnosti korporativnykh informatsionnykh sistem v otechestvennom mashinostroenii [Effectiveness of enterprise information systems in domestic mechanical engineering]. *Issledovaniya po ekonomike informatsionnykh sistem* [Research in economics of information systems]: Proceedings of the scientific and practical conference “Economic efficiency of information business systems” (eds. M.I. Lugachev, K.G. Skripkin). Moscow: MSU, pp. 129–140 (in Russian).

# Информационная эффективность, информационный дизайн и информационная система организации

**Ю.А. Зеленков**

*доктор технических наук, советник генерального конструктора  
НПО «Сатурн»*

*Адрес: 152903, Ярославская обл., г. Рыбинск, пр-т Ленина, д. 163*

*E-mail: yuri.zelenkov@gmail.com*

## Аннотация

В статье предлагается методология анализа системы управления организацией и выбора наиболее актуальной стратегии повышения ее информационной эффективности. Информационная эффективность определяется через объем информации, который необходим для обеспечения процессов координации и мотивации. Обсуждаются четыре стратегии организационного дизайна, направленные на повышение информационной эффективности. Две из них связаны с сокращением объема информации, необходимого для управления: создание буферов (запасов сырья, незавершенного производства и избыточных ресурсов) и декомпозиция системы на независимые рабочие подразделения. Две другие стратегии направлены на увеличение способностей организации обрабатывать информацию: создание информационных систем и создание контекста, способствующего обмену информации.

Показано, что стратегия создания буферов ведет к неэффективности, но стихийно возникает в условиях недостатка информации. Реализация остальных стратегий требует усилий со стороны организации. Обсуждаются подходы к измерению информационной эффективности организации и, поскольку выработка единого способа в настоящее время вряд ли возможна, рекомендуется использовать бенчмаркинг.

Даны оценки объемов информации, которыми оперируют предприятия высокотехнологичного машиностроения в России и за рубежом. Показано, что отечественные предприятия из-за отсталости технологической инфраструктуры вынуждены обрабатывать чрезмерно большие объемы данных, что ведет к информационной перегрузке и, как следствие, созданию буферов на всех этапах производства. Результатом является общая неэффективность предприятия по сравнению с аналогичными зарубежными, причем данное отставание невозможно преодолеть только за счет создания корпоративных информационных систем. В связи с этим представлен пример декомпозиции производственной системы, позволяющей снизить объемы информации для управления.

**Ключевые слова:** эффективность управления, организационный дизайн, система управления производством, производственное планирование, ERP-система.

**Цитирование:** Zelenkov Y.A. Information efficiency, information design and information system of an organization // Business Informatics. 2017. No. 2 (40). P. 25–32. DOI: 10.17323/1998-0663.2017.2.25.32.

## Литература

1. Kohli R., Grover V. Business value of IT: An essay on expanding research directions to keep up with the times // Journal of the Association for Information Systems. 2008. Vol. 9, No. 1. P. 23–39.
2. Mithas S., Ramasubbu N., Sambamurthy V. How information management capability influences firm performance // MIS Quarterly. 2011. Vol. 35. No. 1. P. 237–256.
3. Saunders A., Brynjolfsson E. Valuing information technology related intangible assets // MIS Quarterly. 2016. Vol. 40. No. 1. P. 83–110.
4. Tambe P., Hitt L.M. The productivity of information technology investments: New evidence from IT labor data // Information Systems Research. 2012. Vol. 23. No. 3. Part 1. P. 599–617.
5. Brynjolfsson E., Milgrom P. Complementarity in organizations // The handbook of organizational economics / Eds. R. Gibbons, J. Roberts. Princeton: Princeton University Press, 2013. P. 11–55.

6. Shaul L., Tauber D. Critical success factors in enterprise resource planning systems: Review of the last decade // *ACM Computing Surveys (CSUR)*. 2013. Vol. 45. No. 4. P. 55–55:39.
7. Rivard S., Lapointe L. Information technology implementers' responses to user resistance: Nature and effects // *MIS Quarterly*. 2012. Vol. 36. No. 3. P. 897–920.
8. Taylor H., Artman E., Woelfer J.P. Information technology project risk management: Bridging the gap between research and practice // *Journal of Information Technology*. 2012. Vol. 27. No. 1. P. 17–34.
9. Milgrom P., Roberts J. *Economics, organization and management*. London: Prentice-Hall, 1992.
10. Galbraith J.R. Organizational design: An information processing view // *Army Organizational Effectiveness Journal*. 1984. Vol. 8. No. 1. P. 21–26.
11. Brynjolfsson E., Hitt L. Computing productivity: Firm-level evidence // *Review of Economics and Statistics*. 2003. Vol. 85. No. 4. P. 793–808.
12. Brynjolfsson E., Saunders A. *Wired for innovation: How information technology is reshaping the economy*. Cambridge: MIT Press, 2010.
13. Hopp W.J., Spearman M.L. *Factory physics*. Long Grove, IL: Waveland Press, 2011.
14. Lozano R. Are companies planning their organisational changes for corporate sustainability? An analysis of three case studies on resistance to change and their strategies to overcome it // *Corporate Social Responsibility and Environmental Management*. 2013. Vol. 20. No. 5. P. 275–295.
15. Jacobs G., Van Witteloostuijn A., Christe-Zeyse J. A theoretical framework of organizational change // *Journal of Organizational Change Management*. 2013. Vol. 26. No. 5. P. 772–792.
16. Nonaka I., Toyama R., Hirata T. *Managing flow: A process theory of the knowledge-based firm*. NY: Palgrave Macmillan, 2008.
17. Nahapiet J., Ghoshal S. Social capital, intellectual capital and the organizational advantage // *Academy of Management Review*. 1998. Vol. 23. No. 2. P. 242–266.
18. Zelenkov Y. Components of enterprise IT strategy: decision-making model and efficiency measurement // *International Journal of Information Systems and Change Management*. 2014. Vol. 7. No. 2. P. 150–166.
19. Tarafdar M., Pullins E.B., Ragu-Nathan T.S. Technostress: negative effect on performance and possible mitigations // *Information Systems Journal*. 2015. Vol. 25. No. 2. P. 103–132.
20. Ciborra C. *The labyrinths of information: Challenging the wisdom of system*. NY: Oxford University Press, 2002.
21. Zelenkov Y. Business and IT alignment in turbulent business environment // *Lecture Notes in Business Information Processing*. 2015. No. 228. P. 101–112.
22. Goldratt E.M., Cox J. *The goal: A process of ongoing improvement / 3rd ed.* Great Barrington, MA: The North River Press, 2004.
23. Зеленков Ю.А. Об эффективности корпоративных информационных систем в отечественном машиностроении // *Исследования по экономике информационных систем: Материалы научно-практической конференции «Экономическая эффективность информационных бизнес-систем»* / Под ред. М.И. Лугачева, К.Г. Скрипкина. М.: МГУ, 2015. С. 129–140.



# Horner's Scheme for investigation of solutions of differential equations with polynomial right-hand side<sup>1</sup>

## Alexander P. Afanas'ev

Head of Laboratory of Distributed Computational Systems  
Institute for Information Transmission Problems RAS;  
Professor, Head of Department of High-performance Computations  
of Institute for Information Transmission Problems RAS  
National Research University Higher School of Economics  
Address: 19, build. 1, Bolshoy Karetny Per., Moscow, 127051, Russian Federation  
E-mail: apa@isa.ru

## Sergei M. Dzyuba

Professor, Department of Information Systems  
Tver State Technical University  
Address: 22, Afanasiy Nikitin Embankment, Tver, 170026, Russian Federation  
E-mail: sdzyuba@mail.ru

## Irina I. Emelyanova

Senior Lecturer, Department of Information Systems  
Tver State Technical University  
Address: 22, Afanasiy Nikitin Embankment, Tver, 170026, Russian Federation  
E-mail: emelyanova-123@yandex.ru

### Abstract

We present a method for investigating solutions of systems of ordinary differential equations with polynomial right-hand side. Similar systems are of long-term interest for applications, because many process models have different physical, biological and economical natures described by these systems. The standard methods of numerical analysis are usually applied obtaining system solutions with the polynomial right-hand side, disregarding the specific form of the right-hand side. We suggest a different method starting from the fact that the right side of the equation appears to be a multidimensional polynomial. The relative simplicity of the right-hand side of the system under consideration made it possible to construct by this method approximate analytic solutions in the form of functions not only of time but of the initial conditions as well. In contrast to the majority of known methods, the latter made it possible in many cases to directly trace the systematic computational error. The implementation of the method is based on the construction of a discrete dynamical system along the solutions of the original system with subsequent use of the generalized Horner's Scheme. The computation peculiarity of Horner's Scheme lies in the fact that in many cases the scheme allows us to reduce the number of machine operations required for computation of the polynomial in comparison with the ordinary computation process. The second peculiarity of the generalized Horner's Scheme lies in the fact that there is a good decomposition of computation process that allows us to make calculations in parallel on independent nodes. According to computational experiments, this enables us to reduce computation time hugely even in the simplest cases while retaining required accuracy.

**Key words:** differential equations with polynomial right-hand side, Horner's Scheme, interactive system along solutions, MathCloud system.

**Citation:** Afanas'ev A.P., Dzyuba S.M., Emelyanova I.I. (2017) Horner's Scheme for investigation of solutions of differential equations with polynomial right-hand side. *Business Informatics*, no. 2 (40), pp. 33–39. DOI: 10.17323/1998-0663.2017.2.33.39.

<sup>1</sup>The research was supported by the Russian Scientific Foundation (project No. 16-11-10352)

**Introduction**

Consider the system of ordinary differential equations written in the vector form

$$\dot{x} = f(x), \tag{1}$$

where  $x = (x^1, \dots, x^n)$  is a real vector function of the real variable  $t$  and  $f = (f^1, \dots, f^n)$  is a real vector function in which each element  $f^i$  is a multidimensional polynomial in the variables  $x^1, \dots, x^n$ .

The system (1) has a special meaning in our days. This is explained by numerous models of processes of various physical, economic and other nature as described by such systems (e.g., [1–4]). The special significance of the system is that the strange attractors are quite common.

As is well known, each attractor is a compact invariant set (e.g., [1]). The classical general theory of dynamical systems says that every compact invariant set contains a compact minimal set (e.g., [5]). Therefore, for understanding the structure of strange attractors, constructing the minimal sets is extremely important.

The problem of constructing minimal sets has been posed in the general case only in [6]. As is clear from the results [6], the construction of minimum sets supposes the construction and investigation of the system (1) solutions on infinite horizon for which purpose we need to implement the construction of a certain discrete-time system in the line of primary solutions (see also [7]).

The aim of the present paper is to develop a method for constructing and investigating solutions of system (1) in the MathCloud system. The method is based on a special construction of local solutions of the system taking into account the fact that  $f$  is a multidimensional polynomial [7, 8]. In contrast to the majority of the known methods (e.g. [9–13]), the latter made it possible in many cases to directly trace the systematic computational error. Such tracing is extremely important, e.g., for studying the equations of chaotic dynamics, because computation accuracy in this case plays the decisive role and computations should be performed in rather long time intervals.

**1. Construct local solutions of the system (1)**

First of all, consider the problem of constructing a local solution  $x(t)$  of system (1) with the initial condition

$$x(0) = x_0. \tag{2}$$

Acting in the standard way, replace system (1) by the integral equation

$$x(t) = x_0 + \int_0^t f(x(\tau)) d\tau \tag{3}$$

To find a solution  $x(t)$  of Equation (3), we use the Picard successive approximation method and write

$$x_{N+1}(t) = x_0 + \int_0^t f(x_n(\tau)) d\tau. \tag{4}$$

Assume that

$$x_1(t) = x_0.$$

Then

$$x_2(t) = x_0 + \int_0^t f(x_0) d\tau = x_0 + f(x_0)t.$$

It follows that equality

$$x_3(t) = x_0 + \int_0^t f(x_0 + f(x_0)\tau) d\tau = x_0 + \sum_{i=1}^{\theta_2} \psi_{2,i}(x_0)t^i$$

holds, and  $\theta_2$  is a positive number depending on the polynomial  $f$  and the  $\psi_{2,i}$  are the corresponding real vector functions defined as multidimensional polynomial at the variable  $x_0$ .

Acting formally by induction, using equation

$$x_{N+1}(t) = x_0 + \sum_{i=1}^{\theta_N} \psi_{N,i}(x_0)t^i, \tag{5}$$

where  $\theta_N$  is a positive integer depending only on  $N$  and the polynomial  $f$  and the  $\psi_{N,i}$  are the corresponding real vector functions defined as multidimensional polynomial at the variable  $x_0$ .

The question of the convergence of the sequence  $(x_N)_{N \in \mathbb{N}}$  to the solution  $x(t)$  requires additional investigation. The answer can be found in *Theorem 1* (the proof of *Theorem 1* is contained in paper [7]).

**Theorem 1.** Let  $x_0 \in \mathbb{R}$  be a given point, and let  $\alpha$  be some positive number. Let

$$m = \max_{|x-x_0| \leq \alpha} |f(x)|.$$

Then, for all values  $T > 0$  satisfying relation

$$T \leq \frac{\alpha}{M}.$$

Hold the following equality

$$\lim_{N \rightarrow +\infty} \left| x(t) - x_0 - \sum_{i=1}^{\theta_N} \psi_{N,i}(x_0)t^i \right| = 0.$$

According to *Theorem 1*, formula (5) gives approxi-

mate analytical solutions of system (1) with initial condition (2) defined on  $[-T, T]$ . This approximate analytical solution is a multidimensional polynomial of time  $t$  and vector  $x_0$  which determine the initial state of the system. If the function  $f$  is nonlinear, then an instinctive feature of this representation consists in equality

$$\lim_{N \rightarrow +\infty} \frac{N}{\theta_N} = 0.$$

More than all, equality

$$\lim_{N \rightarrow +\infty} (\theta_{N+1} - \theta_N) = +\infty$$

is always executed.

### 2. Interactive system along solution (1)

Generally speaking, investigation attractors of system (1), if, of course, they exist, suggests the continuation of local solutions to the right on a sufficiently large time interval. In paper [7] one was invited to implement the construction of discrete dynamical system along solution  $x(t)$ .

Let  $x(t)$  be the solution of system (1) with the initial condition (2) defined for all  $t \geq 0$  and is bounded for these  $t$ . Fixed real number  $\mu$  satisfies the relation

$$\alpha = 2\mu \sup_{t \geq 0} |x(t) - x_0|. \tag{6}$$

Let

$$T \leq \frac{\alpha}{2m}, \tag{7}$$

where  $m$  is the number satisfying the conditions of *Theorem 1*.

By  $g^t$  we denote the phase flow for which the field  $f$  if the phase velocity field. Then the relation  $t \geq 0$

$$x(t + kT) = g^t x(kT), \quad k = 0, 1, \dots$$

holds for all  $t \geq 0$ . One can readily see that, by virtue of (6), (4), and (7), for  $t \in [0, T]$ , the points  $g^t x(kT)$  lie in the closed ball

$$B_{\frac{\alpha}{2}}(x(kT)) = \{x \in \mathbb{R}^n : |x - x(kT)| \leq \frac{\alpha}{2}\}$$

and hence in the closed ball

$$B_{\alpha}(x_0) = \{x \in \mathbb{R}^n : |x - x_0| \leq \alpha\}.$$

Therefore, by *Theorem 1* we see that approximation  $g'_N$  to the operator  $g^t$  satisfies equality

$$g'_N x_0 = x_0 + \sum_{i=1}^{\theta_N} \psi_{N,i}(x_0) t^i.$$

Now acting as the paper [7] it is not difficult to prove that it holds.

**Theorem 2.** Let conditions (6), (7) be satisfied for some  $\mu \geq 1$ , and number  $m$  satisfies conditions of *Theorem 1*. Then, for each positive number  $\varepsilon$ , there exists a positive integer  $N_{\varepsilon}$  such that, for  $N > N_{\varepsilon}$ , the inequality

$$\max_{0 \leq t \leq T} |g'_N \xi_0 - g^t \xi_0| < \varepsilon$$

holds for all  $\xi_0 \in B_{\frac{\alpha}{2}}(x_0)$ .

Therefore, for all sufficiently small positive numbers  $T$  the operator  $g^T$  can always be approximated by an operator  $g'_N$  with prescribed accuracy  $\varepsilon$ . However, note that the replacement of  $g^T$  by  $g'_N$  is justified only if the sequence

$$\underbrace{(g'_N \dots g'_N x_0)}_k, \quad k = 0, 1, \dots$$

lies in the ball  $B_{\alpha}(x_0)$ . This means that number  $\mu$  is a parameter that permits one to control the systematic error of calculations.

### 3. Construct of the minimal sets of the Lorenz system

Consider the Lorenz system

$$\begin{cases} \dot{x} = \sigma(y - x), \\ \dot{y} = rx - y - xz, \\ \dot{z} = xy - bz, \end{cases} \tag{8}$$

where  $\sigma$ ,  $r$  and  $b$  are positive numbers, which play the role of system parameters.

For simplicity, we restrict considerations to the following case of classical values of parameters:

$$\sigma = 10, \quad r = 28, \quad b = 8/3.$$

Set

$$x(0) = x_0, \quad y(0) = y_0, \quad z(0) = z_0$$

and

$$g'_N c = (x'_N, y'_N, z'_N), \quad N = 1, 2, \dots,$$

where  $c = (x_0, y_0, z_0)$ . Then, obviously, the relations  $t$

$$x'_1 = x_0, \quad y'_1 = y_0, \quad z'_1 = z_0$$

and

$$\begin{aligned} x'_2 &= 10ty_0 - 10tx_0 + x_0, \\ y'_2 &= -tx_0z_0 - ty_0 + 28tx_0, \\ xz'_2 &= -2.667tz_0 + z_0 + tx_0y_0. \end{aligned}$$

Here have

$$\begin{aligned} x_3' &= -5t^2 x_0 z_0 - 55t^2 y_0 + 10ty_0 + 190t^2 x_0 - 10tx_0 + x_0, \\ y_3' &= 8.889t^3 y_0 z_0 - 5t^2 y_0 z_0 - 8.889t^3 x_0 z_0 + 6.833t^2 x_0 z_0 - \\ &- tx_0 z_0 - 3.333t^3 x_0 y_0^2 + 3.333t^3 x_0^2 y_0 - 0.5t^2 x_0^2 y_0 + 140.5t^2 y_0 - \\ &- ty_0 + y_0 - 154t^2 x_0 + 28tx_0, \\ z_3' &= -3.333t^3 x_0 y_0 z_0 + 3.333t^3 x_0^2 z_0 - 0.5t^2 x_0^2 z_0 + 3.555t^2 z_0 - \\ &- 2.667tz_0 + z_0 - 3.333t^3 y_0^2 + 5t^2 y_0^2 + 96.667t^3 x_0 y_0 - \\ &- 6.833t^2 x_0 y_0 + tx_0 y_0 - 93.333t^3 x_0^2 + 14t^2 x_0^2. \end{aligned}$$

It is very difficult to construct the operator  $g'_N$  for  $N > 3$  without special computer programs. For this purpose, we have used a specially developed software (see Section 4). We cannot cite the regret  $g'_N$  with  $N > 3$ . For example, the operators  $y'_{10}$  and  $z'_{10}$  contain about 30 000 terms.

The minimal sets of system (8) were constructed for a wide range of initial conditions. Here, in particular, consider the construction of the minimal set lying in the  $\omega$ -limit set  $\Omega$  of the solution with the initial condition

$$x_0 = -15.720831, y_0 = -16.587193, z_0 = 36.091132. \quad (9)$$

The *Figure 1* represents the projection of an arc of the orbit  $L$  onto the plane  $xOy$ , constructed for  $T = 0.001$  on the basis of points

$$c, g_N^T c, \dots, \underbrace{g_N^T \dots g_N^T}_k c, \dots$$

with tremendous accuracy

$$\left| \underbrace{g_N^T \dots g_N^T}_k c - \underbrace{g_{N+1}^T \dots g_{N+1}^T}_k c \right| < 10^{-20}.$$

Note that solutions of system (8) are defined and bounded for  $t \geq 0$ . Since  $\mathfrak{C}$  is the unique attractor of system (8), it follows that there exists a limit

$$\liminf_{t \rightarrow +\infty} \inf_{p \in \mathfrak{C}} |g^t q - p| = 0,$$

for almost all  $q \in \mathbb{R}^3[1]$ .

Therefore, it is fair to say that the path  $L$  is set by the desired minimal set to computation error.

#### 4. Horner's Scheme

As was already mentioned, even in the simplest situation of Lorenz system we require multiple computations of a rather complicated multidimensional polynomial for the local solutions construction. With respect to the efficient implementation of this procedure, using special methods is required. For this purpose we have used the generalized Horner's Scheme integrated into the Math-Cloud system [14, 15].

Generally speaking, the description of any version of the generalized Horner's Scheme is extremely awkward. Thus, we will limit ourselves to the situation of four variables polynomial (see Section 4).

Let's consider polynomial

$$p(t, x, y, z) = \sum_{i,j,k,l}^m a_{ijkl} t^i x^j y^k \quad (10)$$

where  $\alpha_{ijkl}$  — are some real numbers and  $t, x, y$  and  $z$  — are real variables. The generalized Horner's Scheme for the polynomial (10) can be depicted as:

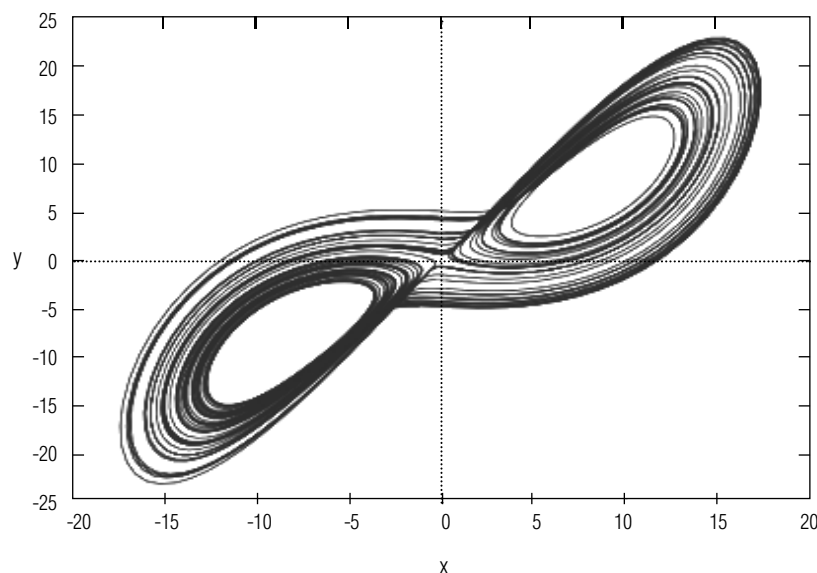

Fig. 1. The projection onto the plane  $xOy$  of an arc of the orbit  $L$  near the attractor  $\mathfrak{C}$  of system (8)

$$p(t,x,y,z) = (\dots((b_m(x,y,z)t + b_{m-1}(x,y,z)t + b_{m-2}(x,y,z)t + \dots)t + b_0(x,y,z)), \quad (11)$$

where

$$b_i(x,y,z) = (\dots((c_{im}(y,z)x + c_{i,m-1}(y,z))x + c_{i,m-2}(y,z))x + \dots)x + c_{i0}(y,z) \quad (12)$$

$$c_{ij}(y,z) = (\dots((d_{ijm}(z)y + d_{ij,m-1}(z))y + d_{ij,m-2}(z))y + \dots)y + d_{ij0}(z) \quad (13)$$

and

$$d_{ijk}(z) = (\dots((\alpha_{ijkm}z + \alpha_{ijk,m-1})z + \alpha_{ijk,m-2})z + \dots) + \alpha_{ijk0} \quad (14)$$

It is obvious that (12)–(14) scheme is good at parallelizing. According to simulation experiments, the use of this scheme (in comparison to direct scheme (11)) at the same level of accuracy makes it possible to essentially reduce the number of computations even in the simplest situations.

For the construction of the Lorenz system minimum set precisely (12)–(14) version of the generalized Horner’s Scheme have been used. A schema of the computation process, using services from the MathCloud system is performed in the *Figure 2*. As a result, the time it takes for the construction of the arc described at the *Figure 1* falls by tens.

### Conclusion

Let’s discuss computation aspects of the suggested method implementation. Let’s recall that in accordance with the method any solution  $x(t)$  of the system (1) is restored in the form of variables  $t, x_0$  multidimensional polynomial where  $x(0) = x_0$  and  $t$  is time. Thus, the storage of the solution obtained comes down to the storage of multidimensional matrix determining this polynomial and matrix determining analytical entry of the expression for the error. One can perform this storage by going through initially all matrix multiplications, or, if more compact, by remembering a parent matrix and set of rules for further conversions. In any case, this storage parallelizes fairly well.

In case of further work with the solution obtained, one for example may need to calculate a trajectory path at given  $x_0$  value at  $t = \tau_1, \tau_2, \dots, \tau_v$  points. It is obvious that each evaluation at  $\tau_i$  instant is independent of others and these evaluations can be done at independent nodes.

As for the evaluation of the multidimensional polynomial, then in the general case this is an ambitious task. It is reasonable to use variations of the generalized Horner’s method to solve the task. There are good grounds to believe that the appropriate procedure will be good at parallelizing.

In relatively simple cases, it is possible to overcome the computational complexity using standard methods and to study complex systems behavior. In the paper, there is an approximate construction of Lorentz system minimum sets as an example of implementation of the results obtained. ■

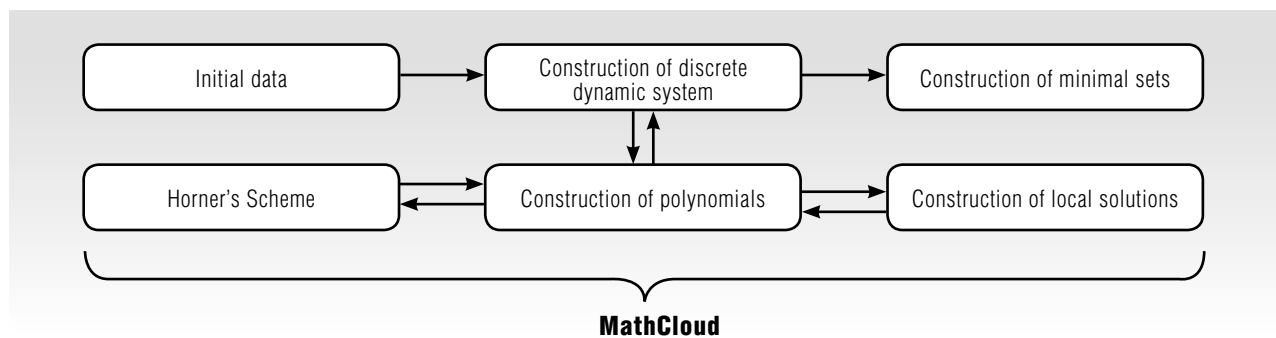

Fig. 2. Computer process organization in the MathCloud system

### References

1. Lorenz E.N. (1963) Deterministic nonperiodic flow. *Journal of Atmospheric Sciences*, no. 20, pp. 130–141.
2. Vallis G.K. (1988) Conceptual models of El Niño and the southern oscillation. *Journal of Geophysical Research*, vol. 98, no. 11, pp. 13979–13991.
3. Bakasov A.A. (1991) Dynamical model of single-mode laser. I. Regime of stable stationary generation. *Theoretical and Mathematical Physics*, vol. 89, no. 2, pp. 278–292.

4. Shapovalov V.I., Kablov V.F., Bashmakov V.A., Avakumov V.E. (2004) Sinergeticheskaya model' ustoychivosti sredney firmy [Synergetic model of stability of a medium company]. *Sinergetika i problemy teorii upravleniya* [Synergetics and problems of control theory]. Moscow, Fizmatlit, pp. 454–464 (in Russian).
5. Nemytskii V.V., Stepanov V.V. (2004) *Kachestvennaya teoriya differentsial'nykh uravneniy* [Qualitative theory of differential equations]. Moscow, 2004 (in Russian).
6. Afanas'ev A.P., Dzyuba S.M. (2015) Method for contraction minimal sets of dynamical systems. *Differential Equations*, vol. 51, no. 7, pp. 831–837.
7. Afanas'ev A.P., Dzyuba S.M. (2015) Construction of the minimal sets of differential equations with polynomial right-hand side. *Differential Equations*, vol. 51, no. 11, pp. 1403–1412.
8. Afanas'ev A.P., Dzyuba S.M. (2015) Method for constructing approximate analytic solutions of differential equations with a polynomial right-hand side. *Computational Mathematics and Mathematical Physics*, vol. 55, no. 10, pp. 1665–1673.
9. Hall G., Watt J.M., eds. (1976) *Modern numerical methods for ordinary differential equations*. Oxford: Clarendon Press.
10. Hairer E., Norsett S.P., Wanner G. (1987) *Solving ordinary differential equations. I: Nonstiff problems*. Berlin: Springer-Verlag.
11. Fedorenko R.P. (2008) *Vvedenie v vychislitel'nyuyu fiziku* [Introduction to computational physics]. Dolgoprudnyi: Intellect, 2008 (in Russian).
12. Demidovich B.P., Maron I.A., Shuvalova E.Z. (2010) *Chislennyye metody analiza. Priblizhenie funktsiy, differentsial'nye i integral'nye uravneniya* [Numerical methods for analysis: Approximation of functions, differential and integral equations]. St. Petersburg: Lan', 2010 (in Russian).
13. Bakhvalov N.S., Zhidkov N.P., Kobelkov G.M. *Chislennyye metody* [Numerical methods]. Moscow: Binom. Laboratory of Knowledge, 2011 (in Russian).
14. Suhoroslov O.V. (2009) Unifitsirovanny interfeys dostupa k algoritmicheskim servisam v Web [The unified interface to access algorithmic services in Web]. *Problemy vychisleniy v raspredelennoy srede. Trudy ISA RAN* [Problems of computations in a distributed environment. Transactions of ISA RAS], vol. 46, pp. 60–82 (in Russian).
15. Afanas'ev A.P., Dzyuba S.M., Emelyanova I.I. (2015) Analytical and numerical investigation for the problem of optimal control of nonlinear system class via quadratic criteria. *Procedia Computer Science*, no. 66, pp. 23–32.

## Схема Горнера для исследования решений дифференциальных уравнений с полиномиальной правой частью<sup>2</sup>

### А.П. Афанасьев

доктор физико-математических наук, профессор  
заведующий лабораторией распределенных вычислительных систем  
Институт проблем передачи информации им. А.А. Харкевича РАН;  
профессор, заведующий базовой кафедрой высокопроизводительных вычислений  
Института проблем передачи информации им. А.А. Харкевича РАН  
Адрес: 127051, г. Москва, Большой Каретный пер., д. 19 стр. 1  
E-mail: apa@isa.ru

### С.М. Дзюба

доктор физико-математических наук, профессор кафедры информационных систем  
Тверской государственной технической университет  
Адрес: 170026, г. Тверь, наб. Афанасия Никитина, д. 22  
E-mail: sdzyuba@mail.ru

### И.И. Емельянова

старший преподаватель кафедры информационных систем  
Тверской государственной технической университет  
Адрес: 170026, г. Тверь, наб. Афанасия Никитина, д. 22  
E-mail: emelyanova-123@yandex.ru

<sup>2</sup> Работа выполнена при поддержке Российского научного фонда (проект 16-11-10352)

**Аннотация**

В статье представлен метод исследования решений систем обыкновенных дифференциальных уравнений с полиномиальной правой частью. Подобные системы давно представляют достаточно большой интерес для приложений, поскольку многие модели процессов различны своей физической, биологической и, главным образом, экономической природой, описываемой данными системами. Для получения решения систем с полиномиальной правой частью обычно используют стандартные методы численного анализа, не учитывая конкретный вид правой части. Мы предлагаем другой метод, использующий тот факт, что правая часть уравнения представляет собой многомерный многочлен. Относительная простота правой части рассматриваемой системы позволила построить этим методом приближенные аналитические решения в виде функций не только времени, но и начальных условий. В отличие от большинства известных методов, последнее во многих случаях позволяет непосредственно отслеживать систематическую ошибку вычислений. Реализация метода основана на построении интерактивной системы вдоль решений исходной системы с последующим использованием обобщенной схемы Горнера. Вычислительная особенность схемы Горнера состоит в том, что она во многих случаях позволяет сократить количество машинных операций, необходимых для вычисления многочлена, по сравнению с обычным вычислительным процессом. Вторая особенность обобщенной схемы Горнера состоит в том, что здесь вычислительный процесс хорошо декомпозируется, что позволяет проводить вычисления параллельно на независимых узлах. Как показали вычислительные эксперименты, это позволяет сократить время вычисления даже в простейших случаях в десятки раз при сохранении заданной точности.

**Ключевые слова:** дифференциальные уравнения с полиномиальной правой частью, схема Горнера, интерактивная система вдоль решений исходной системы, система MathCloud.

**Цитирование:** Afanas'ev A.P., Dzyuba S.M., Emelyanova I.I. Horner's Scheme for investigation of solutions of differential equations with polynomial right-hand side // *Business Informatics*. 2017. No. 2 (40). P. 33–39.  
DOI: 10.17323/1998-0663.2017.2.33.39.

**Литература**

1. Lorenz E.N. Deterministic nonperiodic flow // *Journal of Atmospheric Sciences*. 1963. No. 20. P. 130–141.
2. Vallis G.K. Conceptual models of El Niño and the southern oscillation // *Journal of Geophysical Research*. 1988. Vol. 98. No. 11. P. 13979–13991.
3. Bakasov A.A. Dynamical model of single-mode laser. I. Regime of stable stationary generation // *Theoretical and Mathematical Physics*. 1991. Vol. 89. No. 2. P. 278–292.
4. Шаповалов В.И., Каблов В.Ф., Башмаков В.А., Авакумов В.Е. Синергетическая модель устойчивости средней фирмы // *Синергетика и проблемы теории управления* / Под ред. А.А. Колесникова. – М.: Физматлит, 2004. С. 454–464.
5. Немыцкий В.В., Степанов В.В. Качественная теория дифференциальных уравнений. М., 2004.
6. Afanas'ev A.P., Dzyuba S.M. Method for contraction minimal sets of dynamical systems // *Differential Equations*. 2015. Vol. 51. No. 7. P. 831–837.
7. Afanas'ev A.P., Dzyuba S.M. Construction of the minimal sets of differential equations with polynomial right-hand side // *Differential Equations*. 2015. Vol. 51. No. 11. P. 1403–1412.
8. Afanas'ev A.P., Dzyuba S.M. Method for constructing approximate analytic solutions of differential equations with a polynomial right-hand side // *Computational Mathematics and Mathematical Physics*. 2015. Vol. 55. No. 10. P. 1665–1673.
9. Hall G., Watt J.M., eds. *Modern numerical methods for ordinary differential equations*. Oxford: Clarendon Press, 1976.
10. Hairer E., Norsett S.P., Wanner G. *Solving ordinary differential equations. I: Nonstiff problems*. Berlin: Springer-Verlag, 1987.
11. Федоренко Р.П. Введение в вычислительную физику. Долгопрудный: Интеллект, 2008.
12. Демидович Б.П., Марон И.А., Шувалова Е.З. Численные методы анализа. Приближение функций, дифференциальные и интегральные уравнения. СПб: Лань, 2010.
13. Бахвалов Н.С., Жидков Н.П., Кобельков Г.М. Численные методы. М.: Бином. Лаборатория знаний, 2011.
14. Сухорослов О.В. Унифицированный интерфейс доступа к алгоритмическим сервисам в Web // *Проблемы вычислений в распределенной среде. Труды ИСА РАН* / Под ред. С.В. Емельянова, А.П. Афанасьева. М., 2009. Т. 46. С. 60–82.
15. Afanas'ev A.P., Dzyuba S.M., Emelyanova I.I. (2015) Analytical and numerical investigation for the problem of optimal control of nonlinear system class via quadratic criteria // *Procedia Computer Science*. 2015. No. 66. P. 23–32.

# An algorithm for determining the optimal variant of a cut gem with maximal mass and specified symmetry deviations<sup>1</sup>

**Denis S. Kokorev**

Doctoral Student, Laboratory of Distributed Computational Systems  
Institute for Information Transmission Problems RAS  
Address: 19, build. 1, Bolshoy Karetny Per., Moscow, 127051, Russian Federation  
E-mail: korvin-d@yandex.ru

## Abstract

The article discusses the problem of finding a polyhedron given shape inside another nonconvex polyhedron. This problem is a particular case of the 18th Hilbert problem, third part. It has a practical application in computer simulation of three-dimensional objects, moving autonomous robots, and the jewelry industry. The author uses this mathematical problem to find the facets of gemstones in uncut stones.

The article offers a method for finding inscribed polyhedrons based on the reduction of the problem to a nonlinear programming problem and its solutions using ready-made software. The basic idea is that it is easy to describe this problem in terms of non-linear programming. Internal polyhedron volume is an objective function. Restrictions include the preservation of the combinatorial structure, one polyhedron standing inside another one, convexity, plus additional constraints necessary for practical purposes.

The article describes two implementations of the algorithm: a client-server application and a local application. Their advantages and disadvantages are discussed. The algorithm is described not only in a mathematical point of view; some of its practical characteristics are also demonstrated. Compared to the previous article, the author has added a method that allows for solving the nonconvex case of a problem. This is a significant step forward from a mathematical point of view. In addition, it allows us to use the algorithm at all stages of gem cutting. The end of the article describes current evaluations of the effectiveness and running time, including on weak processors, and it offers plans for further development of the algorithm.

**Key words:** convex polyhedrons, combinatorial structure, inscribed polyhedron, cut gem, symmetry deviation, nonlinear programming problems, solver.

**Citation:** Kokorev D.S. (2017) An algorithm for determining the optimal variant of a cut gem with maximal mass and specified symmetry deviations. *Business Informatics*, no. 2 (40), pp. 40–46.  
DOI: 10.17323/1998-0663.2017.2.40.46.

## Introduction

One of the classical mathematical problems is the third part of Hilbert's eighteenth problem. In its general formulation, it concerns packing of shapes within other shapes. For the case of packing regular shapes, e.g. sphere packing, proven results exist, among which are the following: the strong thirteen

spheres problem [1], the 25 spheres problem [2] and the Kepler conjecture [3]. For the case of packing 2-dimensional polyhedrons and simple 3-dimensional shapes, there are a number of solved problems. Some of these problems are listed in the article by Valiakhmetova and Filippova [4]. In the case of packing multi-dimensional polyhedrons within other polyhedrons, the problem be-

<sup>1</sup>This research was supported by the Russian Scientific Foundation (project No. 16-11-10352)



comes too complicated, and there is no theoretical approach to solving the problem in its general form.

One of the special cases of the problem is the problem of finding a body of specified shape of the largest volume within a nonconvex arbitrarily shaped polyhedron. This problem has a wide range of applications: computer modeling of 3-dimensional shapes; programming simulators; computer games; applications to solve packing and cutting stock problems; robot movement programs; the jewelry industry; the processing of expensive materials. The algorithm described in this article is used for commercial purposes to build an optimal plan for a gem cutter during different stages of gemstone processing.

The first step of the algorithm is to find the starting point, i.e. the approximate starting position of the body being packed. The results of other algorithms may be taken as the starting point. The next step is to gradually shift the vertices of the initial shape by a not very big specified distance and find such positions that result in the largest volume of the body and satisfy a number of conditions previously set on the body's shape.

Currently there are several software products for gem cutters which are used to calculate planning of gemstone cuts. However, all of them work with a finite number of rather strictly symmetrical shapes. The results of their algorithms serve as starting points for the algorithm from this article which distorts the symmetry of the initial shape in the limits allowed by international and manufacturing standards to achieve a larger mass and a higher value of the cut gem.

The algorithm has been implemented as a client-server application for research purposes and as a local application for commercial purposes. For the client-server implementation, external software resources have been used which are organized as RESTful web services [5]. This approach allows us not to spend a lot of time on developing complicated mathematical algorithms instead

of using ready solutions and, therefore, focusing on the task at hand [6]. For the terms used in this paper, refer to the article [7].

### 1. Client-server application

The client-server application has four main steps: input data processing, non-linear problem (NLP) formulation, building the polyhedron from a derived solution, solver calculations (Figure 1). The first step is to transform the input data that might be in different formats into the format necessary for further calculations. The second step is to formulate the initial geometric problem as a problem in terms of nonlinear programming (NLP). After that, the nonlinear solver solves the formulated NLP-problem. This third step happens on the server side and is a black box for the user. Behind the scenes, the server consequently runs several programs organized with the help of RESTful web services. On completion, the solver outputs a set of variables defining the optimal solution which are used to build the desired polyhedron during the fourth step of the algorithm.

The author has tested several solvers for nonlinear programming problems presented on neos-server.org. The tests concerned the problems of finding the optimal cut in convex gemstones. The problems' characteristics were as follows: around 1,000 variables, around 4,000 nonlinear constraints and 3,000 linear constraints. Among the tested solvers were CONOPT, Ipopt, Knitro, LANCELOT, LOQO, MINOS, MOSEK, SNOPT. The objective functions of solutions differed in insignificant figures. Ipopt solver showed the best average time for the given set of problems – 3.50 seconds. The paid solvers MINOS and SNOPT also showed good timings of 5.33 and 4.97 seconds, respectively. Solvers for global optimization have also been tested on simple problems of inscribing convex platonic solids within each other. The Couenne solver showed the best results for these prob-

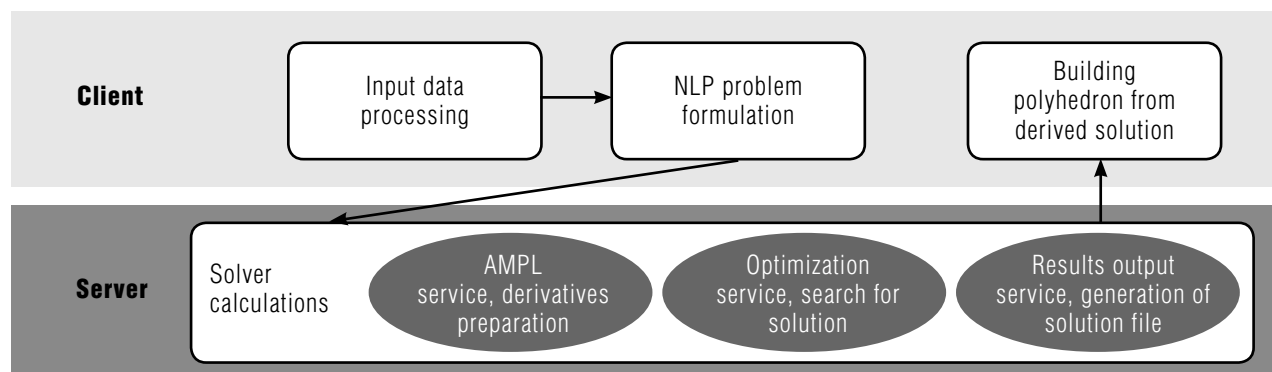

Fig. 1. Client-server application scheme

lems; however, on average, it worked around 300 times longer than Ipop and this is unacceptable in conditions of production. Moreover, Ipop was also able to find global maximums for these simple problems.

Accordingly, for the computations of the given NLP-problem the author chose the Ipop (Internal Point Optimization) solver [8], as the optimization service. This solver is designed to find a local optimum of a nonlinear programming problem using an interior point method. To perform necessary computations, the server needs callback-functions to calculate the following variables:

- ◆ the values of the objective function  $f(x)$ ;
- ◆ the gradient of the objective function  $\nabla f(x)$ ;
- ◆ the ordinate vector of the constraint vector function  $g(x)$ ;
- ◆ the Jacobian of the constraint vector function  $\nabla g(x)^T$ ;
- ◆ the Hessian of the extended Lagrange function

$$\sigma_j \nabla^2 f(x) + \sum_{i=1}^m \lambda_i \nabla^2 g_i(x).$$

If one uses the AMPL programming language [9] for the problem formulation, the language itself provides all these functions for given  $f(x)$  and  $g(x)$ . Thus, one only needs to take care of formulating the NLP-problem in the AMPL format (the formulation of an NLP-problem is discussed in the Chapter 3).

One of the advantages of the client-server approach is the possibility to process any number of problems simultaneously if given the necessary resources. Moreover, the licenses for commercial use of AMPL and Ipop on a server are cheaper than a large number of licenses for local applications.

### 2. Local application

The local application (the box version of the program which is to be installed on personal computers) is need-

ed because most of the software clients are located in developing countries where there is no stable server access through the Internet. AMPL is a paid service and is expensive for commercial use in local applications; to overcome that problem, an interface has been developed and implemented in C++ to work with the Ipop solver directly, without the use of AMPL. The afore-mentioned callback-functions have been written for a narrow set of constraint functions. These functions have the form of cubic polynomials:

$$\sum c_i x_{i1} x_{i2} x_{i3} + \sum c_j x_{j1} x_{j2} + \sum c_k x_k.$$

The sine and cosine functions have also been implemented.

The derivative matrices for such constraints can be written easily, unlike the derivative matrices for the problem in its general form. For the basic algorithm without additional constraints, it is enough to have this representation of the objective function and constraint functions. Moreover, the majority of geometric constraints can be approximated in such form with good enough precision.

The objective function  $f(x)$  and constraints  $g(x)$  are stored in a special form. During each iteration, Ipop refers to the callback-functions written in C++ which calculate the necessary derivatives quickly in the current point (Figure 2). It is crucial to minimize the algorithmic computational complexity of the callback-functions, since they are called a significant number of times.

Ipop is rather resource-intensive in terms of CPU time. Thus, the number of problems that can be solved simultaneously on a computer is equal to the number of cores (or twice the number of multithreading cores). If more problems are launched at the same time, their results will be calculated much more slowly. Ipop can be adjusted so that one task will be solved on several CPUs concurrently, but this gives a tiny boost to performance and does not have much sense in case of a large number of small tasks.

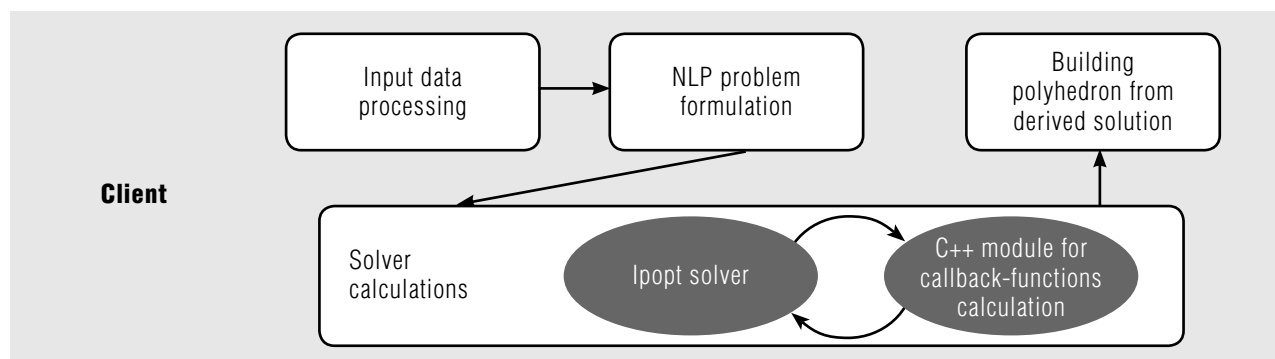

Fig. 2. Local application scheme

For the applied problem being solved in this article, one of the important conditions is to get the solution for any gemstone in limited time, most often in just a minute. In practice, it happens that whatever fixed settings have been chosen, there will always be gems on which Ipopt works longer than the allotted time. That is the reason why all eight runs (keeping in mind a standard modern quad-core processor with multithreading) are performed for the same gemstone with different parameter settings. This approach guarantees getting a result and allows cutting gems of different quality. Gems of different quality are needed because in the jewelry industry the value of a cut gemstone depends not only on its mass. Sometimes it is more profitable to cut a bigger gem of worse quality, and sometimes – a smaller gem of perfect quality.

Apart from that, it turned out that international quality standards are not suitable for appropriate work with nonsymmetrical cut diamonds. A cut diamond, in addition to 3-dimensional symmetry, has a property of optical symmetry, which correlates to how well and symmetrically it sparkles. *Figure 3* shows the course of light in a cut diamond. The more symmetrical the picture, the better the optical symmetry of the cut. The left image presents an optical picture of a perfectly regular cut of 1.0149 carat which was taken as the starting point of the algorithm. The mass of the uncut stone in this example is 1.2904 ct. The right image shows an optical picture of the algorithm result where only the constraints from the international standard of cut diamond quality esti-

mation have been taken into account. The mass of this solution is 1.0601, and it is formally considered to be of highest quality. However, one can easily see that its optical symmetry is far from perfect, therefore the cut diamond will sparkle chaotically and will be difficult to sell. This served as a reason to introduce additional parameters to control optical symmetry of diamonds. The eight simultaneous runs of the algorithm work in such a way that the solutions range from perfect optical symmetry to the largest mass with acceptable quality. For the reviewed example, the algorithm outputs the following range of masses: 1.0601, 1.0428, 1.0406, 1.0368, 1.0356, 1.0316, 1.0315, 1.0268. All the solutions starting from the mass of 1.0428 ct have beautiful enough optical symmetry, while the solution with the mass of 1.0268 ct hardly differs from perfect optical symmetry. A user-friendly interface has also been developed to allow users to run the algorithm with any desirable settings, customize the program for their specific needs and get the cuts of required quality.

### 3. Nonlinear programming problem

The original geometric problem needs to be formulated in terms of nonlinear programming.

The volume of the final cut serves as the objective function  $f(x)$ . It is calculated using the vertices' coordinates through splitting the gem's facets into triangles and presenting the total volume as a sum of simplexes' volumes.

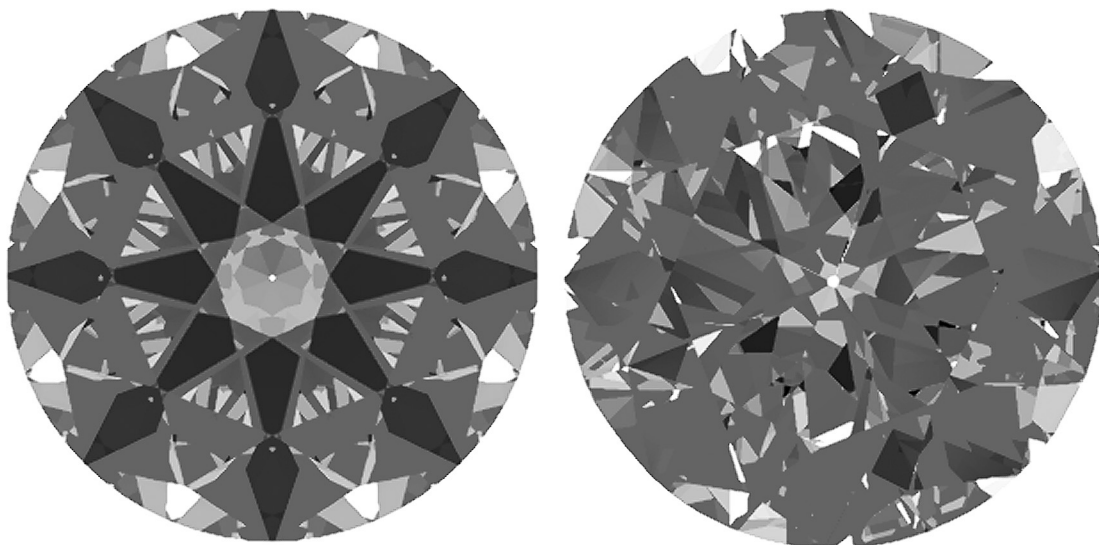

*Fig. 3.* Optical symmetry of a cut diamond

The variables in this problem fall into two types. The first type comprises the parameters of the cut's facets  $y_{ap}$ ,  $y_{bp}$ ,  $y_{cp}$ ,  $y_{dp}$ , where  $p$  is the index of a cut's facet. The constraints on the variables of the first type ( $xU$  and  $xL$ ) are set as the initial values of the parameters plus or minus some specific variable, respectively. The value of this variable depends on the extent to which it is allowed to change the angles of the normals to the facets of the given combinatorial structure. The parameters of a gem's facets never change, hence are treated as constants. The second type of variables comprises the parameters responsible for arranging the cut's vertices in space,  $x_{ji} \in (-\infty, +\infty)$ , where  $j$  is the index of a vertex and  $i$  refers to a coordinate axis. Since a rather precise algorithm is used to set the starting point, it is possible to speed up the calculation process by setting such constraints on the vertices' coordinates so that the vertices cannot move from the initial position further than some variable  $dx$ .

Let us proceed to the description of the general constraints  $g(x)$ . There are several main groups of constraints for the given problem that are bound to be considered. The first group consists of the constraints to preserve the combinatorial structure of the cut:

$$y_{ap}x_{j1} + y_{bp}x_{j2} + y_{cp}x_{j3} - y_{dp} = 0,$$

where  $p$  is a cut's facet index,  $j$  is a vertex index, and the indices 1, 2, 3 refer to the three coordinate axes.

This group of constraints is written out for all pairs of vertices and facets for which it is true that the vertex belongs to the facet. The list of all such pairs can be derived from the original presentation of the polyhedron's facets.

The second group refers to the constraints on the convexity of the required polyhedron. They are written out for each pair of "vertex – facet" where the vertex does not belong to the facet:

$$y_{ap}x_{j1} + y_{bp}x_{j2} + y_{cp}x_{j3} - y_{dp} \leq 0.$$

Since the pairwise convexity of all the adjacent facets serves as a sufficient condition for the convexity of the whole polyhedron, these constraints may be written out only for all the pairs of adjacent facets.

The last group of mandatory conditions deals with the fact that the cut has to stay inscribed in the gemstone. These conditions are written as follows:

$$A_r x_{j1} + B_r x_{j2} + C_r x_{j3} - D_r \leq 0,$$

where  $r$  is the index of a gem's facet, and  $j$  is the index of a cut's vertex.

It is worth noting that  $A_r$ ,  $B_r$ ,  $C_r$ ,  $D_r$  are constants, not variables. Therefore, this group of constraints is linear and does not have a great influence on the execution time of the solver.

Apart from the mandatory constraints, it is also necessary to outline the constraints on the cut's symmetry. For the case of a convex gemstone (i.e. a partially cut gem) you can read more about NLP-problem formulation in the articles [7, 10]. Let us move on to the non-convex case.

For the case when the gemstone is nonconvex, additional constraints are necessary which are responsible for separating the cut from the nonconvex parts of the gem. First, a convex shell of the gem is built. For the constraints described above the facets of this convex shell are used. Next, it is necessary to figure out which facets of the gem are nonconvex. This is preformed using the criterion that a facet is nonconvex if there are two vertices in the polyhedron which lie on different sides of the facet. Then, for each nonconvex facet a separating plane is created. The separating plane is defined by the free variables  $y_a$ ,  $y_b$ ,  $y_c$ ,  $y_d$ . Constraints are imposed on the separating plane such that all the vertices of the nonconvex plane bound to it lie on one side of the separating plane while all the vertices of the cut lie on the opposite side of it. These equations are assigned to each nonconvex facet of the outer polyhedron. If the maximum deviation from the initial position  $dx$  is used for the cut's vertices, then the separating plane may be used to set apart not all the vertices of the inscribed polyhedron, but only the vertices of such facets as may intersect the nonconvex plane of the outer polyhedron. Knowing the value of  $dx$ , it is easy to determine the set of such facets for each nonconvex plane of the outer polyhedron. To simplify the work of the solver, another constraint may be added on the length of the normal to a separating plane to be close to 1.0.

## Conclusion

The algorithm has been implemented as a client-server application and a local application. It has been tested on problems of different scales. The problems varied from ordinary study examples with simple, similar or easily inscribed polyhedrons with the number of vertices less than fifty to real applied problems with the number of vertices ranging from one hundred to several thousands in the nonconvex case and with the constraints on the symmetry of different severity.

To test the algorithm, a system of remote testing has been written in Python which launches the algorithm on

a given database of gems and builds a report with data about all the runs and all the controlled parameters. The testing system is described in more detail in [7].

In real cases, the algorithm improves results of other algorithms from the same application area by 1.5–5% of the volume depending on the constraints imposed on the symmetry. The average gain in mass of the solutions that may be admitted to cutting is 3%.

Main test examples comprised an inscribed polyhedron with the number of vertices and facets around 150 and an outer polyhedron with the number of vertices and facets around 500; the total number of constraints was around 10,000. For examples with a large number of nonconvexities the number of constraints could reach around 40,000. The time to build the problem for these examples approximates one second. The computation time on the solver without symmetry constraints is around 5 seconds. The average computation time on the solver with standard symmetry constraints is 20 seconds. For nonconvex gems, the average time is 29 seconds. All the measurements have been made using Intel(R) Core(TM) i7-2600 CPU @

3.40 GHz. To imitate weaker computers, additional tests have been made with reduced CPU frequency. For the maximum frequencies of 0.9, 1.4, 1.9, 2.4, 2.9 GHz, the average computation times for the problem with constraints are 90, 57, 42, 34, 28 seconds, respectively.

The article discusses two implementations of the algorithm: one with the use of a remote computational resource and one without it. The advantages and disadvantages of both implementations are presented. The algorithm itself is described from a mathematical point of view; its application details and special characteristics are also reviewed. As compared to the previous article [7], a method has been found to solve the nonconvex case of the problem which is a significant step forward from the mathematical point of view. It also allows us to apply the algorithm during all the stages of gemstone cutting. The average working time of the algorithm has been estimated, including that on weak processors. At this stage, the algorithm has been implemented for the most common round cut. In future, it is planned to extend it for other types of cuts. ■

## References

1. Tarasov A., Musin O. (2010) The strong thirteen spheres problem. *Topology, Geometry, and Dynamics: Rokhlin Memorial*. Saint Petersburg, Russia. 11–16 January 2010.
2. Musin O.R. (2003) Problema dvadtsati pyati sfer [The problem of twenty-five spheres]. *Russian Mathematical Surveys*, vol. 58, no. 4 (352), pp. 153–154 (in Russian).
3. Hales T. (1994) The status of the Kepler conjecture. *Mathematical Intelligencer*, no. 16, pp. 47–58.
4. Valiakhmetova Yu.I., Filippova A.S. (2014) Teoriya optimal'nogo ispol'zovaniya resursov L.V. Kantorovicha v zadachakh raskroya – upakovki: Obzor i istoriya razvitiya metodov resheniya [The Kantorovich's theory of optimal use of resources in the cutting and packing problem]. *Vestnik UGATU*, vol. 18, no. 1 (62), pp. 186–197 (in Russian).
5. Afanas'ev A.P., Voloshinov V.V., Lisov A.A., Naumtseva A.K. (2012) Organizatsiya raspredelennoy obrabotki dannykh s pomoshch'yu RESTful-veb-servisov [Organization of distributed data processing using RESTful-web-services]. *Modern problems of science and education*, no. 6 (Technical sciences), p. 31 (in Russian).
6. Voloshinov V.V., Smirnov S.A. (2012) Printsipy integratsii programmnykh resursov v nauchnykh vychisleniyakh [Principles of program resources integration in scientific calculations]. *Information technologies and computer systems*, no. 3, pp. 66–71 (in Russian).
7. Kokorev D.S. (2016) Optimizatsionnyy algoritm poiska vpisannogo mnogogrannika maksimal'nogo ob'ema [An optimization algorithm of determining an inscribed polyhedron of maximal volume]. *Program products and systems*, no. 1, pp. 90–95 (in Russian).
8. Kawajir Y., Laird C., Wächter A. (2010) *Introduction to Ipopt: A tutorial for downloading, installing, and using Ipopt*. Available at: <http://www.coin-or.org/Ipopt/documentation/> (accessed 15 May 2017).
9. Fourer R., Gay D.M., Kernighan B.W. (2003) *AMPL: A modeling language for mathematical programming*. Belmont: Duxbury Press.
10. Kokorev D.S. (2013) Algoritm poiska vypuklogo mnogogrannika maksimal'nogo ob'ema, vpisannogo v drugoy mnogogrannik [An algorithm for search of the convex polyhedrons of maximal volume inscribed in another polyhedrons]. *Information technologies and computer systems*, no. 3, pp. 27–31 (in Russian).

# Алгоритм поиска оптимального варианта огранки драгоценного камня максимальной массы с заданными отклонениями от симметричности<sup>2</sup>

**Д.С. Кокорев**

*аспирант лаборатории распределенных вычислительных систем  
Институт проблем передачи информации им. А.А. Харкевича РАН  
Адрес: 127051, г. Москва, Большой Каретный пер., д. 19, стр. 1  
E-mail: korvin-d@yandex.ru*

## Аннотация

В статье рассматривается задача нахождения многогранников заданной формы внутри других невыпуклых многогранников. Данная задача является частным случаем третьей части 18-й проблемы Гильберта. Она имеет практическое применение в компьютерном моделировании трехмерных объектов, автономном перемещении роботов, ювелирной промышленности. Эта математическая задача интересна с точки зрения ее применения для нахождения огранок драгоценных камней внутри неограненного камня.

В статье предлагается метод поиска вписанных многогранников, основанный на сведении данной задачи к задаче нелинейного программирования и решения ее с помощью готовых программных средств. Основной идеей является то, что задача легко описывается в терминах нелинейного программирования. Целевой функцией является объем искомого многогранника. Ограничения включают в себя сохранение комбинаторной структуры, содержание многогранника внутри другого, выпуклость и дополнительные ограничения, необходимые для практических целей.

В статье рассмотрены две реализации алгоритма: клиент-серверное приложение и локальное приложение. Приведены их достоинства и недостатки. Алгоритм описан не только с математической точки зрения, но и с точки зрения некоторых его прикладных особенностей. По сравнению с предыдущими статьями автора добавлен метод, который позволяет решать невыпуклый случай задачи, что является значительным шагом с математической точки зрения. Кроме того, это позволяет использовать алгоритм на всех этапах огранки драгоценных камней. В конце статьи даны актуальные оценки эффективности и времени работы алгоритма, в том числе на слабых процессорах, и описаны планы дальнейшего развития алгоритма.

**Ключевые слова:** выпуклый многогранник, комбинаторная структура, вписанный многогранник, огранка драгоценного камня, отклонение от симметричности, задача нелинейного программирования, солвер.

**Цитирование:** Kokorev D.S. An algorithm for determining the optimal variant of a cut gem with maximal mass and specified symmetry deviations // Business Informatics. 2017. No. 2 (40). P. 40–46. DOI: 10.17323/1998-0663.2017.2.40.46.

## Литература

1. Tarasov A., Musin O. The strong thirteen spheres problem // Topology, Geometry, and Dynamics: Rokhlin Memorial. Saint Petersburg, Russia. 11–16 January 2010.
2. Мусин О.Р. Проблема двадцати пяти сфер // Успехи математических наук. 2003. Т. 58, № 4 (352). С. 153–154.
3. Hales T. The status of the Kepler conjecture // Mathematical Intelligencer. 1994. No. 16. P. 47–58.
4. Валиахметова Ю.И., Филиппова А.С. Теория оптимального использования ресурсов Л.В. Канторовича в задачах раскроя – упаковки: Обзор и история развития методов решения // Вестник УГАТУ. 2014. Т. 18, № 1 (62). С. 186–197.
5. Афанасьев А.П., Волошинов В.В., Лисов А.А., Наумцева А.К. Организация распределенной обработки данных с помощью RESTful-веб-сервисов // Современные проблемы науки и образования. 2012. № 6 (приложение «Технические науки»). С. 31.
6. Волошинов В.В., Смирнов С.А. Принципы интеграции программных ресурсов в научных вычислениях // Информационные технологии и вычислительные системы. 2012. № 3. С. 66–71.
7. Кокорев Д.С. Оптимизационный алгоритм поиска вписанного многогранника максимального объема // Программные продукты и системы. 2016. № 1. С. 90–95.
8. Kawajir Y., Laird C., Wächter A. Introduction to Ipopt: A tutorial for downloading, installing, and using Ipopt. [Электронный ресурс]: <http://www.coin-or.org/Ipopt/documentation/> (дата обращения 15.05.2017).
9. Fourer R., Gay D.M., Kernighan B.W. AMPL: A modeling language for mathematical programming. Belmont: Duxbury Press, 2003.
10. Кокорев Д.С. Алгоритм поиска выпуклого многогранника максимального объема, вписанного в другой многогранник // Информационные технологии и вычислительные системы. 2013. №3. С. 27–31.

<sup>2</sup> Работа выполнена при поддержке Российского научного фонда (проект 16-11-10352)

# Detecting semantic duplicates in short news items

**Sergei A. Fomin**

*Operator, Laboratory of Research Center*

*Civil Defense Academy EMERCOM of Russia*

*Address: Novogorsk District, Khimki, Moscow Region, 141435, Russian Federation*

*E-mail: sergio-dna@yandex.ru*

**Roman L. Belousov**

*Research Associate, Research Center*

*Civil Defense Academy EMERCOM of Russia*

*Address: Novogorsk District, Khimki, Moscow Region, 141435, Russian Federation*

*E-mail: romabel-87@mail.ru*

## Abstract

In the paper, we examine a task of detecting text messages that borrow similar meaning or relate to the same event. The noticeable feature of the task at hand is that the considered text messages are short, about 40 words per message on average. To solve this task, we design an algorithm that is based on the vector space model, meaning that every text is mapped to a point in high-dimensional space. Text-to-vector transforming is done using the TF-IDF measure. It should be noted that even for small cases with a volume of about 800 messages the dimension of the vector space can exceed 2,000 components, and on the average the dimension is about 8,500 components. To reduce the dimension of space, the method of principal components is used. The application of this method allows us to rationally reduce the dimensionality of space and leave about 3 percent of the components from their original number.

In this reduced vector space, we use agglomerative hierarchical clustering in accordance with the Lance–Williams algorithm. The actual cluster merge is done using the closest linkage algorithm. We stop merging clusters when the distance between two nearest clusters exceeds some threshold value  $r$  that is given to the algorithm as a parameter.

We conduct an experiment on the dataset of 135,000 news messages parsed from news aggregator feeds. During the experiment, we build the regression model for the  $r$  algorithm parameter value that allows us to predict the value of this parameter that gives good clustering results.

The designed algorithm scores high in quality metrics indicating its sufficient ability to classify a pair of messages as being duplicates or not, as well as the ability to find out whole groups of duplicate messages.

**Key words:** short text corpora, text clustering, near-duplicates, semantic vector space, neural network.

**Citation:** Fomin S.A., Belousov R.L. (2017) Detecting semantic duplicates in short news items.

*Business Informatics*, no. 2 (40), pp. 47–56. DOI: 10.17323/1998-0663.2017.2.47.56.

## Introduction

In June 2014, a report entitled “Russian media landscape: television, press, the Internet” [1] was published. The report places particular emphasis on the fact that about one third of the population (34%) uses the Internet in order to “watch the latest news” and 20% to “understand what is happening in the country and abroad”

Public commercial companies and state organizations do not disregard these figures and facts, since an active information policy on the Internet should be conducted in order to create a positive image and unblemished business reputation.

To realize these needs, information systems are being developed which allow for automatic collection, processing and analysis of information from various sources. One

of the key requirements placed on such systems is their ability to detect similar publications, as well as publications devoted to one event (<http://www.mlg.ru/solutions/pr/analysis/>, <https://pressindex.ru/#technology>).

This article addresses the algorithm for retrieving duplicates in short news items received from RSS feeds of various news portals or otherwise.

Duplicates are news items identical in meaning, which can reveal a partial or complete lexical concurrence. Therefore, duplicates have a semantic similarity.

The problem of retrieving duplicates, including short text documents, is not a new one, and papers [2–5] have been dedicated to solution of the problem.

### 1. Initial data

Short news items generally consist of a headline and a lead, the first paragraph that answers the questions what, when and where.

For this study, a collection of short news items for 20 days was used. The volume of the collection is about 135,000 news items. If the items cover the same event, then they have the same duplicate label (*dup*).

Table 1 presents some statistical characteristics of the prepared collection of news items.

Table 1.

Statistical characteristics of a collection on news items

Characteristic	Collection		
	Average	Median	Mode
Number of words in the item	39.72	37	33
Number of unique words in the item	33.77	32	30
Number of items having the same <i>dup</i>	14.73	4	1
Number of items per day	6725.95	6487	–

The average length of items is 39.72 words. The items can have grammatical mistakes and typos. The duplicates are retrieved among the items posted on the same day. The structure and types of the initial data are presented in Table 2.

Table 2.

Structure and type of initial data

<i>id</i>	<i>head</i>	<i>description</i>	<i>time</i>	<i>dup</i>
hash	char	char	smalldatetime	char

Here, *id* is a unique identifier of the item, *head* is an item header, *description* is the main part of the item (lead), *time* is the date and time of the item posting, *dup* is the duplicate label. If two items have the same *dup*, then they are semantic duplicates.

Items which have the same *dup* form groups. Table 3 provides information on a number of such groups. It is noteworthy that the percentage of unique items is insignificant: they are only 2,385 out of 135,000 such items. The collection has 108 groups consisting of 100 or more items (the largest group consists of 1,039 items).

Table 3.

Groups of items

Number of items in a group	Number of groups
1	2385
2	1026
3	649
4	522
5	433
6	351
7	278
8	275
9	229
10	195
> 10	2792

### 2. Problem statement

An article by Yu.G. Zelenkov and I.V. Segalovich is dedicated to the problem of detecting duplicates in text documents. It provides a comparative study of the most popular modern methods of detecting near-duplicates [6]. It is significant that near-duplicates are not always semantically similar, i.e. have the same meaning. Moreover, the methods enabling us to find near-duplicates do not always work correctly for short-length texts.

Therefore, the research task is formulated as follows: to develop an algorithm for detecting semantic duplicates in short news items and grouping them together.



**3. Algorithm description**

The idea of semantic vector space is taken as a basis for the algorithm implementation, where each text is considered as a point in multidimensional space. The closely spaced points correspond to semantically similar documents [7]. Let us consider the description of each algorithm stage and tools for their implementation.

**The first stage is preprocessing.** The items posted on one day are aggregated into smaller size corpora. After that, all words in the items are brought to a normal form using the morphological analyzer Mystem (<https://tech.yandex.ru/mystem/>). Therefore, the original collection of items  $C$  can be considered as a combination of aggregated corpora  $c_i$ :

$$C = \bigcup_i c_i. \tag{1}$$

The collection of short news items under study is divided into 20 corpora, since it contains items for 20 days.

**The second stage is a construction** of the vector space model. The items from corpus  $c_i$  must be converted to a matrix. To solve this problem the TF-IDF measure [8] is used.

For each word  $t$  in a particular item  $d$ , a TF-measure is calculated by the formula (2):

$$tf(t,d) = \frac{n_i}{\sum_k n_k}, \tag{2}$$

where  $n_i$  is a number of entries of word  $t$  to item  $d$ ;

$\sum_k n_k$  is a total number of words in item  $d$ .

For each word  $t$  in text corpus  $c_i$  the IDF-measure is calculated by the formula (3):

$$idf(t,c_i) = \log \frac{|c_i|}{|(d_i \supset t)|}, \tag{3}$$

where  $|c_i|$  is number of items in corpus  $c_i$ ;

$|(d_i \supset t)|$  is the number of items in which word  $t$  is found.

Thus, each item is converted into a vector, which component is a TF-IDF measure of each word in this item. For a specific word, the TF-IDF measure is defined as a product of TF and IDF measures.

The TF measure for the word is defined locally in each item, and the IDF measure is global for the corpus and does not depend on a specific item. Value TF-IDF is interpreted as a “contribution” of a particular word to the meaning of the item.

The result of implementation of the second stage is represented in the form of a matrix (Table 4), where

each column defines a separate word  $t$  from corpus  $c_i$ , and each row corresponds to some item  $d$ .

Table 4.

**TF-IDF matrix**

	$t_1$	$t_2$	...	$t_m$
$d_1$	$tf - idf(d_1, t_1)$	0	...	$tf - idf(d_1, t_m)$
$d_2$	0	0	...	$tf - idf(d_2, t_2)$
...	...	...	...	...
$d_n$	$tf - idf(d_n, t_1)$	...	...	$tf - idf(d_n, t_m)$

When constructing a vector space model, words with a high degree of frequency and those which occur once are ignored. For the presented initial data, high-frequency words are those which are encountered in more than 90% of the items.

To build the vector space model, the machine-learning library scikit-learn (<http://scikit-learn.org/stable/>) was used for the Python programming language.

**The third stage is to decrease the number of vector components.** The purpose of this stage is to reduce the data dimension, since on average each matrix corresponding to item corpus  $c_i$  contains 8,547 columns. To reduce the number of columns in Table 4 with a minimum loss of information content, principal component analysis is used.

Each column of Table 4 is variable  $t_i$ , and the row is a number of observations. All variables  $t_i$  are centered by the formula (4):

$$x_i = t_i - \bar{t}_i, \tag{4}$$

where  $\bar{t}_i$  is an average value of variable  $t_i$ .

After that, a transition to new variables is accomplished – to the principal component by the formula (5):

$$pc_j = \sum_i^m v_{ij} \cdot x_i, \tag{5}$$

in this case the sum of squares of weight coefficients  $v_{ij}$  shall have a unit value.

New variables  $pc_1, pc_2, \dots, pc_m$  are created such that the following conditions [9] are fulfilled:

- ◆ the first principal component  $pc_1$  has a maximum possible sampling variance  $sVar(pc_1)$ ;
- ◆ variable  $pc_2$  is uncorrelated with  $pc_1$  and has a maximum possible sampling variance  $sVar(pc_2)$ ;
- ◆ variable  $pc_3$  is uncorrelated with  $pc_1, pc_2$  and has a maximum possible sampling variance  $sVar(pc_3)$ ;
- ◆ etc.

To reduce the number of columns in *Table 4*, it is sufficient to omit the variables which have the least weights in the linear combination (5).

The number of columns in the new table is calculated as a product of the number of columns in the old table and parameter  $m$ , where  $m \in (0, 1]$ . It is found that if parameter  $m$  varies from 0.02 to 0.1, the quality of the algorithm's work slightly varies. Values  $m$  exceeding 0.1 increase the computational cost of the subsequent operations. The most rational value of parameter  $m$  equals 0.03.

The principal component analysis (PCA) is also implemented in the machine-learning library scikit-learn.

**The fourth stage is to measure commonality of two vectors.** After implementing the third stage, the number of columns in *Table 4* was reduced, but the number of rows remained unchanged. Each row corresponds to a specific text (document)  $d$  and is considered as a vector.

The most popular method of measuring the commonality of two vectors is to find the cosine of the angle between them [7]. The higher the cosine value, the more similar are the vectors.

For the convenience of further use of clustering algorithms, the cosine value is subtracted from the unit. The result is a matrix of cosine distances  $A$ :

$$a_{ij} = 1 - \cos(d_i, d_j). \quad (6)$$

Finding the cosine of the angle between two vectors is implemented in the data analysis library scikit-learn for Python programming language.

It is important to note that the value of the cosine does not yet allow us to judge whether the two items are semantic duplicates.

**The fifth stage is to cluster the vectors.** The items that fall into the same groups are semantically similar, and the appropriate vectors form clusters.

To cluster vectors  $\mathbf{d}$ , agglomerative hierarchical clustering is used. The purpose of this clustering is as follows. First, each vector corresponding to a text item is treated as a separate cluster. The distances between these clusters are contained in matrix  $\mathbf{A}$  obtained in the fourth stage of the algorithm.

Then the merge process is started. In each iteration, a new cluster  $W = U \cup V$  instead of a pair of the closest clusters  $U$  and  $V$  is formed. The distance from new cluster  $W$  to any other cluster  $S$  is calculated by the Lance–Williams algorithm [10]:

$$R(W, S) = \alpha_U R(U, S) + \alpha_V R(V, S) + \beta R(U, V) + \gamma |R(U, S) - R(V, S)|, \quad (7)$$

where distances  $R(U, S)$ ,  $R(V, S)$ ,  $R(U, V)$  and numeric parameters  $\alpha_U$ ,  $\alpha_V$ ,  $\beta$ ,  $\gamma$  are calculated by the nearest neighbors algorithm [10]:

$$R(W, S) = \min_{w \in W, s \in S} \rho(w, s), \quad (8)$$

$$\alpha_U = \frac{1}{2}, \quad \alpha_V = \frac{1}{2}, \quad \beta = 0, \quad \gamma = -\frac{1}{2}.$$

The process of merging clusters is terminated when the distance between two clusters exceeds a certain value of parameter  $r$ .

This agglomerative clustering algorithm is implemented in the machine learning library scikit-learn.

The agglomerative clustering algorithm presented enables us to find pairs of semantic duplicates and combine them into groups.

#### 4. Numerical experiment

Within the numerical experiment, the algorithm quality was evaluated taking into account, on the one hand, the ability to classify text item pairs as semantic duplicates, and on the other hand, the ability to cluster the duplicates found.

To evaluate the algorithm abilities to combine items into sense-groups, i.e. assessment of the clustering quality, the adjusted Rand Index (ARI) [11] and the Adjusted Mutual Information Index (AMI) are applied [12].

The ARI and AMI indexes present a measure of agreement and a measure of similarity between two partitions of a set of objects, respectively.

The classification of items was evaluated according to the following metrics: accuracy ( $P$ ), completeness ( $R$ ) and  $F$ -measure – a harmonic mean between the accuracy and completeness [13]. Using these metrics, the algorithm's ability to classify pairs of text items as semantic duplicates is determined. For convenience of perception of the classification results, let us designate a class of duplicates by digit 1, and a class of non-duplicates by digit 0.

Let us give an example. If two items that fall into the same group have the same *dup* in *Table 2* (class 1), then the classification has been done correctly and semantic duplicates (class 1) are found. This classification is called true-positive ( $TP$ ).

Another example. Two items are classified as semantic duplicates (class 1), i.e. they fell into one group. In this case, these items have different *dups* in *Table 2* (class 0). This goes to prove that the algorithm incorrectly classified this pair of items. Such a solution is called a false-positive ( $FP$ ).

A true-negative *TN* and false-negative *FN* classification are distinguished.

The above classification types and selected metrics are related by formula (9):

$$P = \frac{TP}{TP + FP}, R = \frac{TP}{TP + FN}, F = 2 \frac{P \cdot R}{P + R}. \quad (9)$$

The metrics considered and quality indexes are implemented in the machine-learning library scikit-learn.

The main part in evaluating algorithm quality is played by clustering parameter *r*, which is determined by the agglomerative clustering. It is obvious that the optimal value of parameter *r* depends on the individual features of the corpus of short news items. A value that maximizes the *F*-measure in class 1 is considered to be an optimal value *r* for a separate corpus. It is worth noting that the term “optimality” is used in the narrow sense. This means that resulting values *r* are optimal only for certain algorithm setting parameters. For other setting parameter values, the optimum values may vary.

Therefore, an answer to the question “How much does the value of parameter *r* depend on these features, and can it be predicted?” is of practical interest.

**The first stage** of the experiment consisted in empirical selection of such a value of clustering parameter *r*, at which the *F*-measure in class 1 reaches its greatest value. It is class 1 that determines the algorithm quality, inasmuch as by virtue of the specifics of the data under study, the completeness and accuracy in class 0 are always close to unit.

Figure 1 depicts a graph of variance of selected metrics (accuracy, completeness, *F*-measure for class 1)

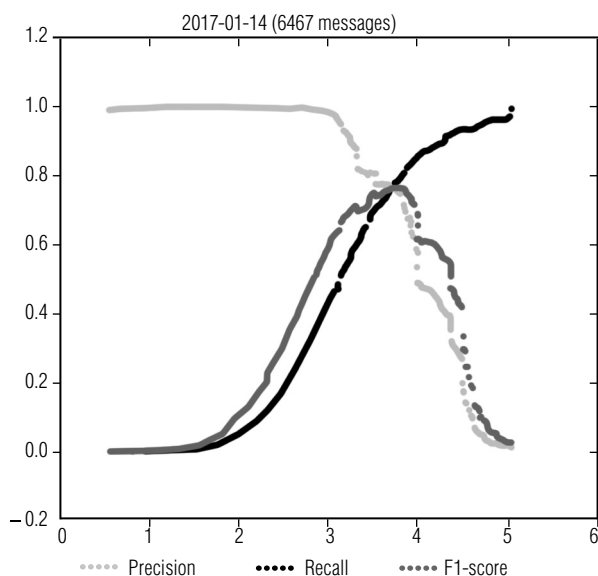

Fig. 1. Quality of classification (class 1) of pairs of corpus items

depending on the values of clustering parameter *r* for a random text corpus from the collection under study. The graph has a pronounced discreteness. This is due to the peculiarities of the agglomerative clustering: since each value of parameter *r* determines the distance between the clusters, and a number of clusters is limited, then the metrics quality values can vary only on a certain limited set of values of clustering parameter *r*.

Table 5 depicts values of the classification metrics, values of the clustering metrics for each corpus *c<sub>i</sub>* and appropriate values of parameter *r*.

Table 5.

Matrix values

<i>c<sub>i</sub></i>	Algorithm quality					<i>r</i>
	Classification			Clustering		
	<i>P</i>	<i>R</i>	<i>F</i>	<i>ARI</i>	<i>AMI</i>	
855	0.93	0.75	0.83	0.83	0.83	2.05
2117	0.78	0.91	0.84	0.84	0.90	2.79
6056	0.66	0.67	0.67	0.67	0.76	3.59
7553	0.87	0.65	0.74	0.74	0.75	3.68
4142	0.69	0.83	0.75	0.75	0.769	3.88
2934	0.80	0.76	0.78	0.77	0.84	3.02
5093	0.75	0.77	0.76	0.76	0.82	3.44
6478	0.79	0.69	0.74	0.74	0.73	3.35
6869	0.72	0.76	0.74	0.74	0.83	3.89
6350	0.77	0.63	0.69	0.69	0.79	3.61
7097	0.73	0.72	0.73	0.73	0.77	3.78
6496	0.73	0.62	0.67	0.67	0.68	3.31
8366	0.71	0.73	0.72	0.72	0.81	4.04
11745	0.76	0.67	0.71	0.71	0.72	4.01
11106	0.79	0.75	0.77	0.77	0.79	4.20
7568	0.77	0.64	0.70	0.70	0.70	3.47
12221	0.76	0.74	0.75	0.75	0.80	4.46
10472	0.71	0.76	0.73	0.73	0.78	4.15
6467	0.76	0.78	0.77	0.77	0.83	3.72
4534	0.86	0.76	0.81	0.81	0.82	3.29

The data analysis in Table 5 makes it possible to draw the conclusion that if the value of clustering parameter *r* is chosen correctly, then the algorithm quality can be estimated as good. However, the value of parameter *r* can vary greatly for each corpus.

**The second stage** of the experiment consisted in finding the dependence of the value of clustering parameter *r* on the individual features of the corpora of short news items.

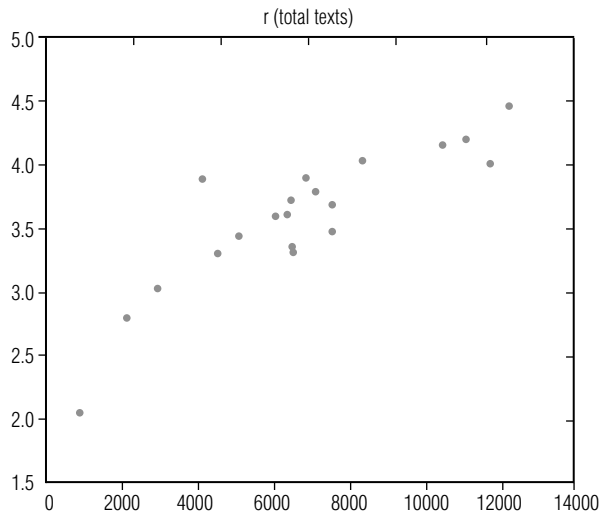

Fig. 2. Dependence of the optimal value of parameter  $r$  from a number of items

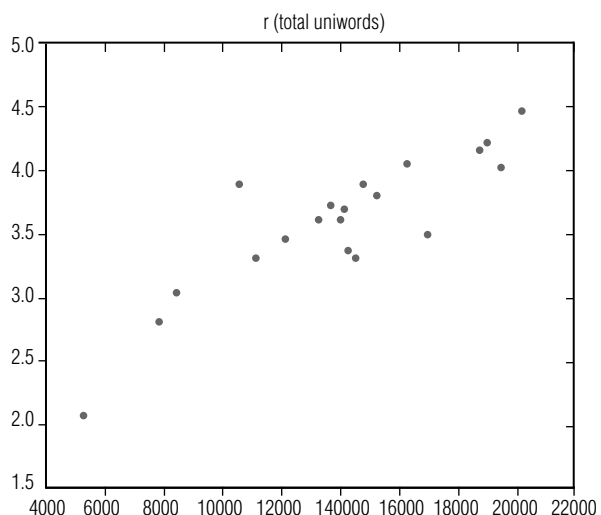

Fig. 3. Dependence of the optimal value of parameter  $r$  from the number of unique words in the corpus

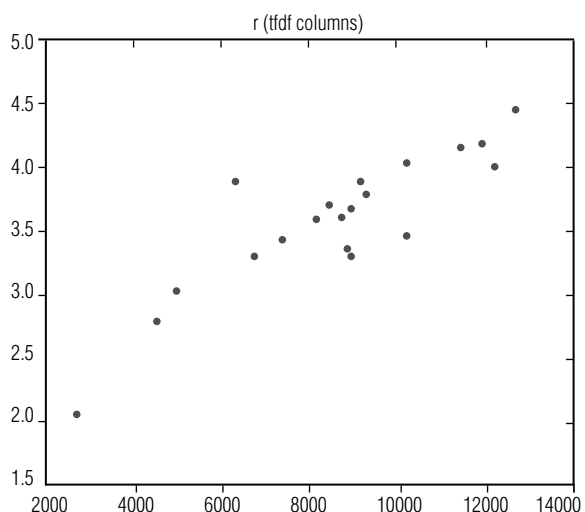

Fig. 4. Dependence of the optimal value of parameter  $r$  from the number of columns on the TF-IDF matrix

Individual features of the corpus of short news items can be determined by values of the following parameters:

- $p_1$  is the number of items in the corpus;
- $p_2$  is the average length of items;
- $p_3$  is the most widely used (mode) length of items;
- $p_4$  is the average number of unique words in the items;
- $p_5$  is the mode of the number of unique words in the items;
- $p_6$  is the total number of unique words in the corpus;
- $p_7$  is the number of columns of TF-IDF matrix (Table 4);
- $p_8$  is the clustering parameter  $r$ .

Among the values of the parameters obtained during the experiment, some regularities were detected.

For example, with an increase of the number of items in corpus  $p_1$ , the clustering parameter  $r$  as a whole also increases (Figure 2).

Figure 3 depicts a growth trend for the optimal value of parameter  $r$  with the increase of a number of unique words in corpus  $p_6$ .

Figure 4 depicts a dependence diagram of the optimal value of parameter  $r$  from  $p_7$  – the number of columns in the TF-IDF matrix.

Two models will be used to predict the values of clustering parameter  $r$  based on the values of input variables  $p_1, \dots, p_7$ : the multilinear regression model and the neural network model (MLP *i-h-o*, *hidden*, *output*), where  $i$  is the dimension of the input value vector,  $h$  is a number of neurons in the hidden layer,  $o$  is a dimension of the output vector, *hidden* is an activation function of the neurons of the hidden layer, *output* is a function of activating neurons of the output layer.

The multilinear regression model appears as follows:

$$p_8 = \beta_0 + \beta_1 p_1 + \beta_2 p_2 + \dots + \beta_7 p_7 + \varepsilon, \quad (10)$$

where  $\varepsilon$  is a random component, error;

$\beta_i$  – unknown parameters.

The unknown parameters  $\tilde{\beta}_i$  of model (10) are estimated by the least-square method. For testing the model quality, the sliding control procedure for individual objects (leave-one-out CV) [14, 15] was used: 19 observations, where each observation contains the values of parameters  $p_1, p_2, \dots, p_8$ , were used as a training sample for constructing the multilinear regression model, 1 observation was used for monitoring, i.e. predicting parameter  $r$ .

Taking into consideration the fact that the collection has 20 corpora with a total volume of about 135,000

items, 20 iterations of cross-validation were carried out. Table 6 depicts the cross-validation results for multilinear regression model (10).

Table 6.

**Cross-validation results for multilinear regression model**

c <sub>i</sub>	R <sub>2</sub>	Prediction evaluation	
		r <sub>i</sub>	$\tilde{r}_i$
855	0.85	2.051	2.783
2117	0.89	2.793	2.480
6056	0.90	3.599	3.326
7553	0.91	3.689	4.160
4142	0.92	3.889	3.217
2934	0.89	3.029	2.986
5093	0.90	3.441	3.631
6478	0.90	3.354	3.65
6869	0.90	3.895	3.588
6350	0.90	3.611	3.466
7097	0.91	3.787	4.159
6496	0.91	3.314	3.675
8366	0.90	4.043	3.787
11745	0.91	4.014	4.432
11106	0.89	4.203	4.057
7568	0.90	3.476	3.617
12221	0.88	4.465	4.319
10472	0.90	4.159	3.884
6467	0.90	3.721	3.616
4534	0.89	3.297	3.296

In the above Table, |c<sub>i</sub>| is the number of items in corpus c<sub>i</sub>; R<sup>2</sup> is a coefficient of determination of the model built based on 19 observations; r<sub>i</sub> is a real optimal value of the clustering parameter in corpus; c<sub>i</sub>;  $\tilde{r}_i$  is a predicted value.

The neural network model is represented by a three-layer architecture of the neural network, including an input layer, a hidden layer and an output layer. The neural network was trained using the Broyden–Fletcher–Goldfarb–Shanno (BFGS) algorithm, which allows us to minimize the error sum of squares (sos).

To use the neural network model of the neural network model, a preliminary processing of the input data is conducted, which consists in scaling each input and output

variable according to formula (11), so that all values of the variable belong to interval [0, 1]:

$$\delta = \frac{1}{p_i^{max} - p_i^{min}}, \tag{11}$$

$$p'_i = 0 - \delta \cdot p_i^{min} + \delta \cdot p_i,$$

where p<sub>i</sub><sup>max</sup>, p<sub>i</sub><sup>min</sup> are minimum and maximum values of variable p<sub>i</sub>;

p'<sub>i</sub> is a scaling variable.

Table 7 provides the cross-validation results for the neural network model with architecture (MLP i-h-o, hidden, output).

Table 7.

**Cross-validation results for the neural network model**

c <sub>i</sub>	MLP network configuration	R <sup>2</sup>	Prediction estimation	
			r <sub>i</sub>	$\tilde{r}_i$
855	7-12-1, log, log	0.97	2.051	2.818
2117	7-7-1, exp, exp	0.97	2.793	2.778
6056	7-6-1, tanh, tanh	0.97	3.599	3.597
7553	7-8-1, tanh, ident	0.85	3.689	3.732
4142	7-7-1, tanh, log	0.86	3.889	3.662
2934	7-4-1, ident, ident	0.88	3.029	2.992
5093	7-10-1, log, tanh	0.80	3.441	3.585
6478	7-6-1, exp, tanh	0.96	3.354	3.444
6869	7-8-1, ident, log	0.75	3.895	3.855
6350	7-12-1, tanh, log	0.90	3.611	3.617
7097	7-12-1, exp, ident	0.98	3.787	3.785
6496	7-9-1, exp, exp	0.97	3.314	3.494
8366	7-11-1, tanh, exp	0.92	4.043	3.916
11745	7-11-1, log, ident	0.85	4.014	4.113
11106	7-5-1, exp, log	0.93	4.203	4.203
7568	7-10-1, ident, tanh	0.90	3.476	3.539
12221	7-10-1, exp, log	0.95	4.465	4.202
10472	7-5-1, tanh, log	0.91	4.159	4.004
6467	7-4-1, exp, exp	0.95	3.721	3.720
4534	7-4-1, log, tanh	0.92	3.297	3.286

Table 8 presents a comparison of the algorithm quality factors obtained for the optimal values of clustering parameter r and the values predicted by the two models, respectively.

Table 8.

**Comparison of the algorithm quality factors**

Optimal value					
	<i>P</i>	<i>R</i>	<i>F</i>	<i>ARI</i>	<i>AMI</i>
Min	0.66	0.62	0.67	0.67	0.69
Max	0.93	0.91	0.84	0.84	0.90
Average	0.77	0.73	0.75	0.74	0.79
Multilinear regression					
	<i>P</i>	<i>R</i>	<i>F</i>	<i>ARI</i>	<i>AMI</i>
Min	0.29	0.39	0.44	0.43	0.68
Max	0.88	0.95	0.82	0.81	0.84
Average	0.68	0.71	0.67	0.67	0.77
Neural network model					
	<i>P</i>	<i>R</i>	<i>F</i>	<i>ARI</i>	<i>AMI</i>
Min	0.55	0.63	0.64	0.64	0.69
Max	0.86	0.95	0.84	0.84	0.90
Average	0.72	0.74	0.73	0.72	0.79

Analysis of the results obtained makes it possible to draw the following conclusions.

The values of the clustering parameter  $r$  obtained using the neural network model allow us to increase the algorithm quality and approach the optimal parameters taking into account the preset settings of algorithm parameters.

The results of the numerical experiment confirmed the fact that the proposed algorithm, on the one hand, is

able to classify items as semantic duplicates, and, on the other hand, combine the duplicates found into groups based only on the frequency characteristics of corpora and texts.

**Conclusion**

This article presents an algorithm of retrieving semantic duplicates in short news items based on the idea of semantic vector space [7]. With this approach, each news item is considered as a point in the multidimensional space.

For quality assessment, metrics are introduced which evaluate the algorithm's ability to classify the items as semantic duplicates and combine the duplicates found into groups.

It has been established that the algorithm quality depends heavily on clustering parameter  $r$ . The paper proposes models which make it possible to predict parameter  $r$  based on the characteristics of the text corpus under study.

The algorithm developed showed a quite acceptable work quality.

It is assumed that the algorithm work quality can be improved by using methods that take into account the context, for example, word2vec and doc2vec [16].

For practical application of the proposed algorithm, the optimization method is also to be developed. That will enable us to reduce the algorithm running time and reduce the memory requirements. In the current algorithm implementation, the time and memory requirements increase as a square of a number of items in the text corpus. ■

**References**

1. Volkov D., Goncharov S. (2014) *Rossiyskiy media-landshaft: televidenie, pressa, Internet* [The Russian media landscape: TV, press, Internet]. (in Russian).
2. Rangrej A., Kulkarni S., Tendulkar A.V. (2011) Comparative study of clustering techniques for short text documents. Proceedings of the 20th International World Wide Web Conference (WWW 2011). Hyderabad, India, 28 March – 01 April 2011, pp. 111–112.
3. Errecalde M.L., Ingaramo D.A., Rosso P. (2010) A new AntTree-based algorithm for clustering short-text corpora. *Journal of Computer Science and Technology*, vol. 10, no. 1, pp. 1–7.
4. Petersen H., Poon J. (2011) Enhancing short text clustering with small external repositories. Proceedings of the 9th Australasian Data Mining Conference (AusDM'11). Ballarat, Australia, 01–02 December 2011, pp. 79–89.
5. Kirichenko K.M., Gerasimov M.B. (2001) *Obzor metodov klasterizatsii tekstovoy informatsii* [Review of text information clustering methods]. Available at: <http://www.dialog-21.ru/en/digest/2001/articles/kirichenko/> (accessed 17 January 2017) (in Russian).
6. Zelenkov Yu.G., Segalovich I.V. (2007) *Sravnitel'nyy analiz metodov opredeleniya nechetkikh dublikatov dlya Web-dokumentov* [Comparative analysis of methods for near-duplicate detection for Web-documents]. Available at: [download.yandex.ru/company/paper\\_65\\_v1.rtf](http://download.yandex.ru/company/paper_65_v1.rtf) (accessed 28 September 2016) (in Russian).
7. Turney P.D., Pantel P. (2010) From frequency to meaning: Vector space models of semantics. *Journal of Artificial Intelligence Research*, no. 37, pp. 141–188.
8. Wu H.C., Luk R.W.P., Wong K.F., Kwok K.L. (2008) Interpreting TF-IDF term weights as making relevance decisions. *ACM Transactions on Information Systems*, vol. 26, no. 3, pp. 13.1–13.37.
9. Aivazyan S.A., Buhstaber V.M., Enyukov I.S., Meshalkin L.D. (1989) *Prikladnaya statistika. Klassifikatsiya i snizhenie razmernosti* [Applied statistics. Classification and reduction of dimensionality]. Moscow: Finance and Statistics (in Russian).

10. Vorontsov K.K. *Leksii po algoritmam klasterizatsii i mnogomernogo shkalirovaniya* [Lectures on algorithms of clustering and multidimensional scaling]. Available at: <http://www.ccas.ru/voron/download/Clustering.pdf> (accessed 28 September 2016) (in Russian).
11. Hubert L., Arabie P. (1985) Comparing partitions. *Journal of Classification*, no. 2, pp. 193–218.
12. Vinh N.X., Epps J., Bailey J. (2010) Information theoretic measures for clusterings comparison: Variants, properties, normalization and correction for chance. *Journal of Machine Learning Research*, no. 11, pp. 2837–2854.
13. Sokolov E. (2015) *Seminary po vyboru modeley* [Workshops on models selection]. Available at: [http://www.machinelearning.ru/wiki/images/1/1c/Sem06\\_metrics.pdf](http://www.machinelearning.ru/wiki/images/1/1c/Sem06_metrics.pdf) (accessed 17 January 2017) (in Russian).
14. Kohavi R. (1995) A study of cross-validation and bootstrap for accuracy estimation and model selection. Proceedings of the *Fourteenth International Joint Conference on Artificial Intelligence (IJCAI 95)*. Montreal, Quebec, Canada, 20–25 August 1995, vol. 2, pp. 1137–1145.
15. Refaeilzadeh P., Tang L., Liu H. (2009) Cross-validation. *Encyclopedia of Database Systems*. Springer, pp. 532–538.
16. Shuriga L. *Sovremennye metody analiza tonal'nosti teksta* [Modern methods of sentiment analysis in text]. Available at: <http://datareview.info/article/sovremennyye-metodyi-analiza-tonalnosti-teksta/> (accessed 01 February 2017) (in Russian).

## Поиск семантических дубликатов в коротких новостных сообщениях

### С.А. Фомин

бакалавр технических наук  
оператор лаборатории научно-исследовательского центра  
Академия гражданской защиты МЧС России  
Адрес: 141435, Московская область, г. Химки, мкр. Новогорск  
E-mail: [sergio-dna@yandex.ru](mailto:sergio-dna@yandex.ru)

### Р.Л. Белоусов

кандидат технических наук, научный сотрудник научно-исследовательского центра  
Академия гражданской защиты МЧС России  
Адрес: 141435, Московская область, г. Химки, мкр. Новогорск  
E-mail: [romabel-87@mail.ru](mailto:romabel-87@mail.ru)

#### Аннотация

В статье рассмотрена задача, связанная с обнаружением публикаций, схожих по смыслу, а также публикаций, посвященных одному событию. Особенность решаемой задачи заключается в том, что в качестве публикаций рассматриваются короткие новостные сообщения, средняя длина которых составляет 40 слов. Для решения указанной задачи разработан алгоритм, в основу которого положена векторная модель семантики, где каждый текст рассматривается как точка в многомерном пространстве. Преобразование корпуса текстов в матрицу производится с помощью меры TF-IDF. Необходимо отметить, что даже для небольших корпусов (объемом порядка 800 сообщений) размерность векторного пространства может превосходить 2000 компонент, а в среднем размерность составляет около 8500 компонент. Для сокращения размерности пространства используется метод главных компонент. Его применение позволяет рационально сократить размерность пространства и оставить около трех процентов компонент от их исходного количества.

В сокращенном пространстве для объединения векторов в кластеры применяется агломеративная иерархическая кластеризация по алгоритму Ланса–Уильямса, который запускает процесс слияния кластеров. Слияние кластеров производится с помощью вычисления расстояния между ближайшими элементами этих кластеров. Процесс слияния кластеров прекращается в том случае, если расстояние между двумя кластерами превышает некоторое значение  $r$ .

При проведении численного эксперимента построена регрессионная модель, позволяющая найти наиболее подходящее значение параметра  $r$  для каждого корпуса сообщений. В качестве исходных данных для проведения численного эксперимента использовалась коллекция коротких новостей, общий объем которых составляет около 135 тысяч сообщений.

Разработанный алгоритм имеет достаточно высокие показатели качества, которые учитывают, с одной стороны, способность классифицировать пары текстовых сообщений как семантические дубликаты, а с другой – способность объединять найденные дубликаты в группы.

**Ключевые слова:** коллекция коротких текстовых сообщений, кластеризация текстов, нечеткие дубликаты, векторная модель семантики, нейронная сеть.

**Цитирование:** Fomin S.A., Belousov R.L. Detecting semantic duplicates in short news items // Business Informatics. 2017. No. 2 (40). P. 47–56. DOI: 10.17323/1998-0663.2017.2.47.56.

### Литература

1. Волков Д., Гончаров С. Российский медиа-ландшафт: телевидение, пресса, Интернет. [Электронный ресурс] (дата обращения 14.10.2015).
2. Rangrej A., Kulkarni S., Tendulkar A.V. Comparative study of clustering techniques for short text documents // Proceedings of the 20th International World Wide Web Conference (WWW 2011). Hyderabad, India, 28 March – 01 April 2011. P. 111–112.
3. Errecalde M.L., Ingaramo D.A., Rosso P. A new AntTree-based algorithm for clustering short-text corpora // Journal of Computer Science and Technology. 2010. Vol. 10. No. 1. P. 1–7.
4. Petersen H., Poon J. Enhancing short text clustering with small external repositories // Proceedings of the 9th Australasian Data Mining Conference (AusDM'11). Ballarat, Australia, 01–02 December 2011. P. 79–89.
5. Кириченко К.М., Герасимов М. Б. Обзор методов кластеризации текстовой информации. [Электронный ресурс]: <http://www.dialog-21.ru/en/digest/2001/articles/kirichenko/> (дата обращения 17.01.2017).
6. Зеленков Ю.Г., Сегалович И.В. Сравнительный анализ методов определения нечетких дубликатов для Web-документов // Труды 9-й Всероссийской научной конференции «Электронные библиотеки: перспективные методы и технологии, электронные коллекции» (RCDL'2007). Переславль-Залесский, Россия. 15–18 октября 2007 г. С. 166–174.
7. Turney P.D., Pantel P. From frequency to meaning: Vector space models of semantics // Journal of Artificial Intelligence Research. 2010. No. 37. P. 141–188.
8. Interpreting TF-IDF term weights as making relevance decisions / H.C. Wu [et al.] // ACM Transactions on Information Systems. 2008. Vol. 26. No. 3. P. 13.1–13.37.
9. Прикладная статистика. Классификация и снижение размерности / С.А. Айвазян и [др.]. М.: Финансы и статистика, 1989.
10. Воронцов К.К. Лекции по алгоритмам кластеризации и многомерного шкалирования. [Электронный ресурс]: <http://www.ccas.ru/voron/download/Clustering.pdf> (дата обращения 28.09.2016).
11. Hubert L., Arabie P. Comparing partitions // Journal of Classification. 1985. No. 2. P. 193–218.
12. Vinh N.X., Epps J., Bailey J. Information theoretic measures for clusterings comparison: Variants, properties, normalization and correction for chance // Journal of Machine Learning Research. 2010. No. 11. P. 2837–2854.
13. Соколов Е. Семинары по выбору моделей. [Электронный ресурс]: [http://www.machinelearning.ru/wiki/images/1/1c/Sem06\\_metrics.pdf](http://www.machinelearning.ru/wiki/images/1/1c/Sem06_metrics.pdf) (дата обращения 17.01.2017).
14. Kohavi R. A study of cross-validation and bootstrap for accuracy estimation and model selection // Proceedings of the Fourteenth International Joint Conference on Artificial Intelligence (IJCAI 95). Montreal, Quebec, Canada, 20–25 August 1995. Vol. 2. P. 1137–1145.
15. Refaeilzadeh P., Tang L., Liu H. Cross-validation // Encyclopedia of Database Systems. Springer, 2009. P. 532–538.
16. Шурига Л. Современные методы анализа тональности текста. [Электронный ресурс]: <http://datareviewinfo/article/sovremennyye-metodyi-analiza-tonalnosti-teksta/> (дата обращения 01.02.2017).



# A simulation model for educational process planning in an institution of higher education

## Alexander A. Gorbunov

Lecturer, Department of Information Systems and Digital Infrastructure Management  
National Research University Higher School of Economics  
Address: 20, Myasnitskaya Street, Moscow, 101000, Russian Federation  
E-mail: agorbunov@hse.ru

## Eugeni A. Isaev

Professor, Head of Department of Information Systems and Digital Infrastructure Management  
National Research University Higher School of Economics  
Address: 20, Myasnitskaya Street, Moscow, 101000, Russian Federation  
E-mail: eisaev@hse.ru

## Alexander F. Morgunov

Associate Professor, Head of Department of Information Systems and Digital Infrastructure Management  
National Research University Higher School of Economics  
Address: 20, Myasnitskaya Street, Moscow, 101000, Russian Federation  
E-mail: amorgunov@hse.ru

### Abstract

In universities and technical colleges with relevant IT qualifications in one semester multiple streams, courses and specializations can use software products for training purposes. IT services of universities should deal with the challenge of creating the infrastructure of educational applications that can support the educational process. We note that the number of specializations which study information technology are growing every year (for example, in HSE there are disciplines-minors, which can enroll students coming from any field). Also in the recent years, online courses have started to become popular. If the load is not planned ahead taking into account future trends, the power of even the most high-tech infrastructure will be insufficient. Calculation of the corresponding load on the infrastructure must be made in the planning process of the disciplines, so that we can reserve appropriate facilities, and thus organize an effective learning process.

Software developers use a variety of benchmarking tools that are complex and do not provide the necessary information for the participants of educational process planning.

This article discusses the construction of a simulation model that supports the educational process planning. The simulation is carried out using the capabilities of the tool AnyLogic 7. The aim of this work is to develop a simulation model designed to estimate the load on the information system used in the educational process. In addition, besides the description of the model, the article presents the results of calculations used for various options of the information system (private cloud or on a server at the university). The simulation results were confirmed by data obtained during practical classes at the university. This model gives us the opportunity to plan the educational process in order to achieve uniformity of the load on the services. If necessary, the model allows us to make a decision about the location of the educational information system: on servers of the university or in a private cloud.

**Key words:** educational process, information system, ERP system, simulation model, private cloud, IT infrastructure.

**Citation:** Gorbunov A.A., Isaev E.A., Morgunov A.F. (2017) A simulation model for educational process planning in an institution of higher education. *Business Informatics*, no. 2 (40), pp. 57–67.  
DOI: 10.17323/1998-0663.2017.2.57.67.

**Introduction**

Simulation [1–3] is widely used in various fields of science and industry. In scientific publications we see the results of the simulation of complex economic [4], socio-economic [5] and technological systems [6].

Models of technical systems, in particular, allow us to estimate the load on the server hardware. Similar problems arise, for example, in the implementation and operation of corporate information systems. In higher educational institutions, for the training of students to work with corporate information systems one can use the resources of private cloud or cloud server infrastructure. For effective practical training, staff involved in the planning of the educational process must have information about the load on its infrastructure. Such assessment is particularly large at the stage of educational planning and curriculum development. Uniform distribution of load on the equipment during the school year helps to avoid disruptions when working and, as a result, affect the efficiency of study time.

**1. Formulation of the problem**

In *Figure 1*, we see the planning process of disciplines for which teaching requires equipped computer classes and access to specialized software types – ERP, CPM and CRM.

For educational institutions, leading Russian and foreign vendors of software provide facilities for the use of software products from a private cloud that eliminates the need to install, purchase licenses, create infrastructure, access, etc. The capability is limited and, as practice shows (*Table 1*), does not always provide stable, productive work while training a large number of students in one period.

In universities and technical colleges with relevant IT qualifications in one semester multiple streams, courses and specializations can be adapted to work with software products. IT services of universities should deal with the challenge of creating the infrastructure of educational applications that can support the educational process. We note that the number of specializations which study information technology are growing every year (for example, in HSE there are disciplines-minors, which can

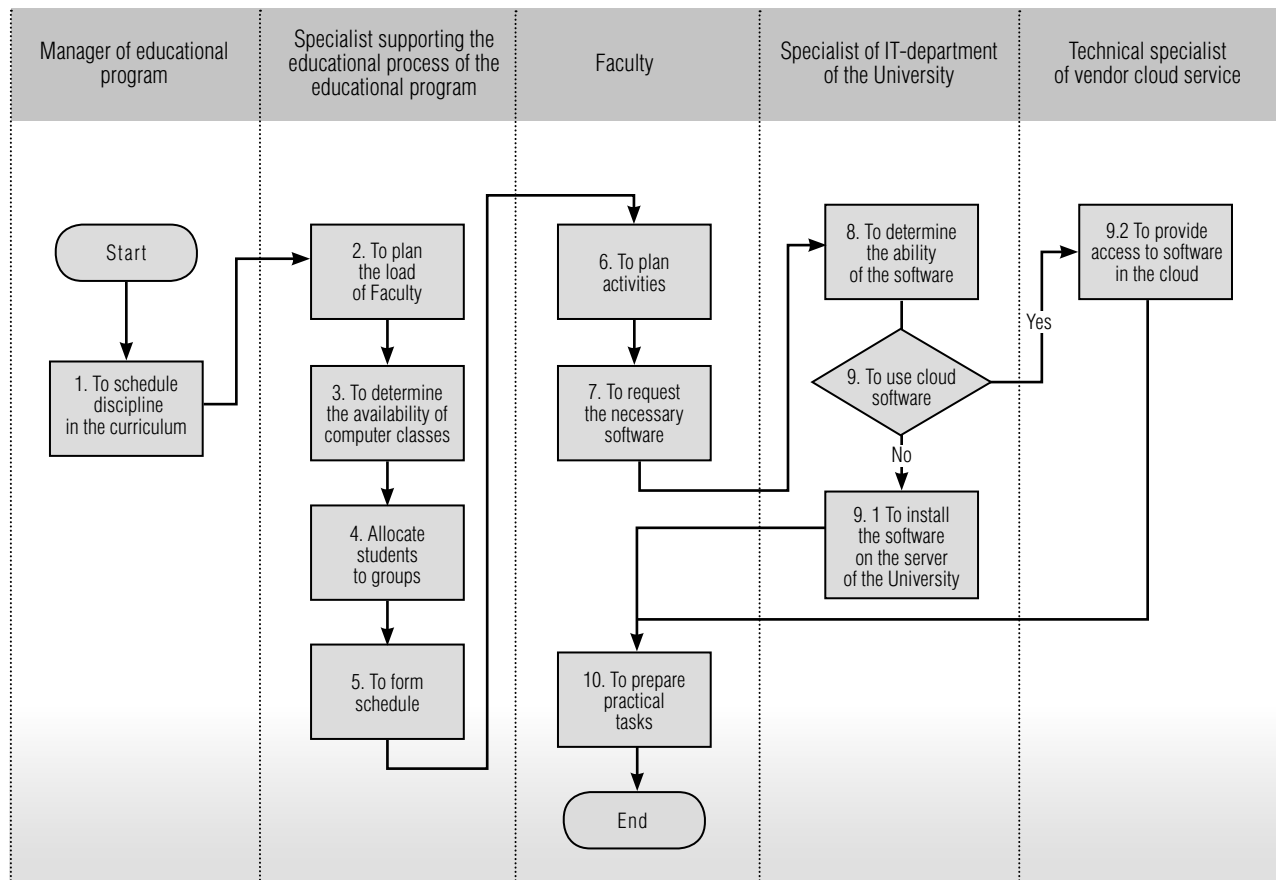

Fig. 1. The planning process of disciplines

Table 1.

The observed performance of cloud services

Service provider (vendor)	Software	The number of trainees in the semester	Time of the service unavailability (days)	Time of slow service (days)
SAP	SAP ERP	400	5	10
1C	1C:Manufacturing Enterprise Management (ERP Solution)		15	36

enroll students coming from any field). Also in the recent years, online courses have started to become popular. If the load is not planned to take into account future trends, the power of even the most high-tech infrastructure will be insufficient. Calculation of the corresponding load on the infrastructure is necessary to perform the planning process of the disciplines. This allows us to reserve appropriate facilities, and thus to organize an effective learning process.

Software developers use a variety of benchmarking tools that are complex and do not provide the necessary information to participants in planning the educational process.

The aim of this work is to develop a simulation model designed to estimate the load on the information system used in the educational process.

To achieve this objective, the following tasks are solved:

- ◆ the definition of simulation parameters for simulations which will provide the information necessary for participants of the process of planning the educational process;
- ◆ the development of a mathematical model and its implementation in AnyLogic 7;
- ◆ experimental design and comparison of results with real observations.

**2. Assumptions of the model**

The simulation model relies on several assumptions which are proved practically throughout the period of use of the ERP system.

**Assumption 1.** Practical classes attended by students who pass the completed tasks at a different time. By the duration of tasks, students can be divided into groups as follows:

- ◆ executes the exercises in time;
- ◆ performs tasks beyond the classroom (or earlier);
- ◆ performs tasks in time (if the student has not completed the practice during the lessons, the task runs in extracurricular time up to the next class);
- ◆ performs the task with a delay:

- ◆ performs tasks one week after the deadline;
- ◆ performs tasks two weeks after the deadline;
- ◆ performs tasks for a few days before the exam at the end of the semester.

**Assumption 2.** We assume that students are ready for practice and the execution time of the task affects only the performance and availability of the service. The following service parameters:

- ◆ slower application performance (the majority of users of the system are waiting while performing operations):
  - ◆ during class;
  - ◆ in extracurricular time;
  - ◆ application unavailability:
    - ◆ during class;
    - ◆ in extracurricular time.

**Assumption 3.** Executing time varies for practical tasks in the various service states. For example, the estimated execution time of the user under the following conditions: the service is available and running slow – 2 hours, service is available and running fast – 1.5 hours.

**Assumption 4.** The performance and availability of the service provided by the resources of the server.

Practical classes on “Corporate information systems” and “Information systems management” are taught at the Higher School of Economics (HSE) between September to December 2016. At this period of training with the use of a cloud service, the tasks were carried out by 400 undergraduate students of senior courses.

The students were divided as follows:

- ◆ 240 4th year students of “Management” carried out practical classes in groups with a maximum number of 15 people – 16 subgroups;
- ◆ 160 3rd year students of various disciplines in the framework of university discipline (minor) performed work in groups, with a maximum of 32 people – 5 subgroups.

It should also be noted that the students had no previous knowledge of corporate systems and had no

practical skills to perform practical tasks based on experience. However, they had received the necessary information from the teacher at the beginning of the class. This clarification eliminated the connection between previous skills of work and completing practical tasks on time.

**Assumption 5.** If the service is available and the application works well or slowly, the student can perform the task during class time or perform it in extracurricular time.

**Assumption 6.** In the organization of ERP systems in the university infrastructure, the resources of a single server will be used to support the performance and availability of the two applications.

For modelling purposes, there are several practical scenarios to be performed by groups of students on ERP systems of different vendors (or one vendor); the systems use the resources of a single server. Thus, it is possible to imagine a model as a queueing system [7, 8] in which there are three sources (students performing scenarios), the request queue from two information systems and the one server that will handle the requests.

As instrumentation for modelling using the functionality of AnyLogic 7 [4].

### 3. Features and key design parameters of the model

#### 3.1. Calculation of the values of various time parameters by individual characteristics of students

Students attend classes on a schedule; the number of those who come to classes is displayed at blocks *Main\_Dis*, *Sub\_Dis*, *Second\_Dis*. Those students who arrive enter in the queue which simulates students waiting while the lecturer explains the instructions for executing tasks, gives the theoretical basis and so forth. (block *wait1*, *wait2* or *wait3*) (Figure 2).

The length of time the teacher explains the material  $\tau_0$  is a random value distributed in the range of 10–30 minutes, depending on the rank  $r > 0$  (complexity of challenge):

$$\tau_0 = U(10,30) \cdot \frac{r}{2}, \quad (1)$$

where  $U(10,30)$  is a function of the uniform distribution with parameters 10, 30.

After the teacher’s explanation, students begin practical training with a certain time delay  $\tau_i''$ ,  $i \in \{1, \dots, n\}$ , which depends on the speed of task execution, which is individual for each student (Formula 3).

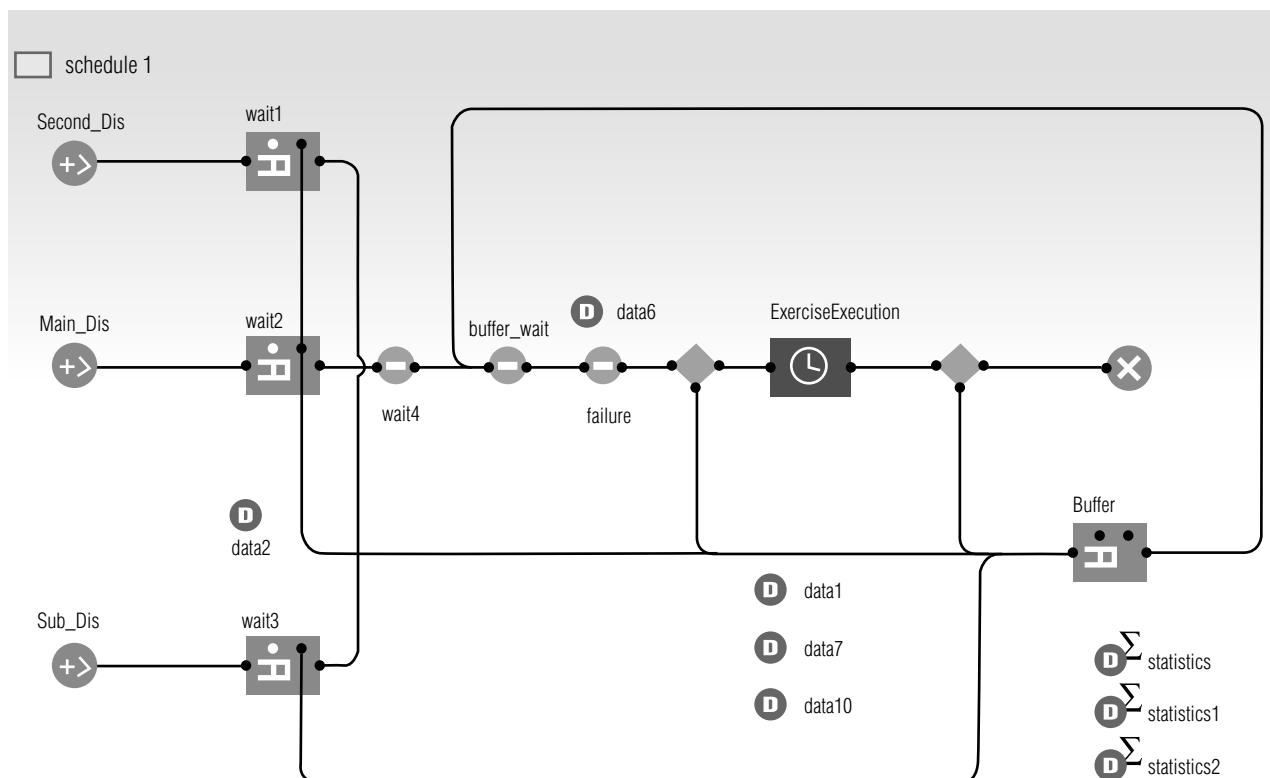

Fig. 2. The logical scheme of the simulation model

The execution speed of the task ( $k_i$ ) indicates the percentage of lesson time that the  $i$ -th student is busy executing it. Let the variable  $d$  time of class, then the following formula is fair:

◆ to compute the time during which the  $i$ -th student busy completing tasks in class:

$$\tau_i' = k_i d - \tau_0 \quad (2)$$

◆ to calculate time delay before starting the execution of the task by the  $i$ -th student:

$$\tau_i'' = (1 - k_i) \cdot d. \quad (3)$$

Time of class can be calculated as the sum of the time parameters:

$$d = \tau_0 + \tau_i' + \tau_i'' \quad (4)$$

When a student enrolls in one of the blocks (*Main\_Dis*, *Sub\_Dis*, *Second\_Dis*), a value of execution speed is assigned which is calculated in the following way: choose a random uniformly distributed number from the interval  $[0, 1)$ , which is multiplied by 100.

The smaller the value  $k_i$ , the less time the student is busy performing practical tasks  $\tau_i'$  and the more time  $\tau_i''$  is delayed before starting the task.

**Example 1.** Let students solve the task, the complexity (rank)  $r = 2$ . According to Formula 1, calculate the time explaining the task by the teacher  $\tau_0 = 30$  min. Calculate parameters  $\tau_i', \tau_i''$  of the model for two students ( $i = 1, 2$ ). Assume that the speed of execution of tasks of the first and second students  $k_1 = 0.85, k_2 = 0.4$ . Then, after the class time  $d$  (2 hours 40 minutes) the first student may be busy performing tasks within the time

$$\tau_1' = 0,85 \cdot (2 \text{ h. } 40 \text{ min.}) - 30 \text{ min} = 1 \text{ h. } 46 \text{ min.},$$

and the second student during the time

$$\tau_2' = 0,4 \cdot (2 \text{ h. } 40 \text{ min.}) - 30 \text{ min.} = 34 \text{ min. (Formula 2).}$$

Thus the time delay before starting the job for the first student is  $\tau_1'' = 24$  minutes, and for the second one –

$$\tau_2'' = 1 \text{ hour } 36 \text{ minutes (Formula 3).}$$

The result of simulation experiments to establish the number of students able to perform the practical task of rank  $r$  for the class and those who require out-of-class time for self-study work, the following notation is introduced:

$t_{j1}, t_{j2}$  – start and end time of the  $j$ -th class,  $j \in \{1, \dots, m\}$ , where  $m$  is the number of classes;

$t_{ij}$  – the time of the completion of the  $j$ -th job by the  $i$ -th student ( $t_{ij} \geq 0$ );

$z$  – calculated (reference) execution time of the task (constant, determined by the teacher);

$g_i(t_{ij}, \tau_i')$  – the probability that the  $i$ -th student is potentially able to perform the  $j$ -th task:

$$g_i(t_{ij}, \tau_i') = \begin{cases} 1, & \text{if } z \leq \tau_i' \text{ and } t_{ij} \leq t_{j2} \\ 0, & \text{if } z > \tau_i' \text{ and } (z \leq \tau_i' \text{ and } t_{ij} > t_{j2}). \end{cases} \quad (5)$$

**Example 2.** Based on the calculations given in example 1, determine which of the two students is able to perform the first ( $j = 1$ ) task whose rank is  $r = 2$ . Let the class begin at the time  $t_{j1} = 12$  hours 10 minutes, end in a moment  $t_{j2} = 15$  hours 00 minutes, while the estimated execution time of the task defined by the teacher, is  $z = 1$  hour 40 minutes. The first student completes the task at the moment  $t_{i1} = 14$  hours 50 minutes. Applying Formula 5, we get:  $g_1(t_{i1}, \tau_1') = 1$  (1 h. 40 min.  $\leq$  1 h. 46 min.; 14 h. 50 min.  $\leq$  15 h. 00 min.). For the second student, the first parameter does not matter, since  $z = 1$  h. 40 min.  $>$   $\tau_2' = 34$  min.,  $g_2(t_{i1}, \tau_2') = 0$ . Thus, of the two students, only the first will be able to perform the task in class, and the second will require extracurricular time.

Students who require time for extracurricular activities ( $g_i(t_{ij}, \tau_i') = 0$ , the block *Buffer*), can enter the system to finish exercises not completed in the normal time of classes  $d$ . Login (block *wait\_buffer*) extracurricular time occurs through certain time intervals that are distributed exponentially. The number of logons (number of hits in the buffer) of the  $i$ -th student to complete practical tasks is determined by the formula (square brackets mean that only integral part is taken):

$$c = \left[ \frac{z}{\tau_i'} - 1 \right] \cdot 100. \quad (6)$$

Student  $i$  completes a practical assignment and is removed from the buffer after he enters the system  $c$  times.

**Example 3.** In example 2, it is shown that one of the students will require extracurricular time to complete job 1. In order to determine how many times the student will be able to define the extracurricular time, calculate the  $c$  parameter. As the value of the parameter used, we take the value calculated in example 1. Perform the calculation:

$$c = \left[ \frac{1 \text{ h. } 40 \text{ min.}}{34 \text{ min.}} - 1 \right] \cdot 100 = 100.$$

### 3.2. Calculation of influence of indicators of reliability of the computing infrastructure of the cloud service educational ERP system at various time parameters

The real computational infrastructure that supports the educational ERP system cloud service is opaque,

and this presents difficulties for developing a simulation model. Among the scientific works dedicated to the topic of computing system architectures we highlighted the publications of V.G. Khoroshevsky [6], which presents the method of calculation of indicators of reliability and feasibility of the solution of tasks using computer systems. Assume that the computing infrastructure of the cloud service corresponds to the architecture of the computing system with structural redundancy [6].

This computer system looks to the user as a virtual system having the number of elementary machines [6], which power allows us to carry out the implementation tasks, appropriate ranks (tasks of appropriate difficulty). Use the techniques of [6], assuming that the rank of a task is the number of elementary machines that balancing the load while practice is executing with the maximum number of users.

The essence of this assumption is the following: if there is a possibility that practical exercises (tasks) are executed simultaneously by multiple users (students), it means that some elementary machines are required for the implementation of the solution of the task. The number of elementary machines (EM) equals the rank of the task. Theoretically, it should always avoid a situation of significant load (for hours, days and so forth) on computing infrastructure as follows from observations of the delivery of practical tasks within the discipline providing for the execution of works with the use of the software.

Let  $R(t)$ ,  $U(t)$  – is a function respectively of reliability and recovery of a system with structural redundancy. The mean uptime and mean time to repair computing system (CS) can be calculated by the formula [6]:

$$\theta = \int_0^{\infty} R(t) dt \quad (7)$$

$$T = \int_0^{\infty} t dU(t). \quad (8)$$

If average uptime decreases, then  $\tau_i''$  (average delay time before the start) increases, and  $\tau_i'$  (time of occupation of the student in class) is reduced. Also, for a given it is true that the average number of students who will perform tasks during the class will decrease, while the average number of students who require out-of-class time will increase. Thus, when the average uptime is reduced, the buffer will be on average higher than when operating in failover mode.

### 3.3. Determination of the influence of the intensity of the task flow at different time parameters

Suppose that the computational system of cloud service is running in the maintenance mode task flow. Then the simplification of the General case can be considered [6]. In the general case, there are tasks of different ranks  $1 \leq r \leq N$ , where  $N$  – the number of elementary machines (EM) in the computational network (CN). One or more subsystems are allocated for each rank to load balancing of EM, the number of which is equal to the corresponding rank. To determine the feasibility of the task solution, we must calculate the following parameters: mean of the number of tasks in the system and the number of occupied EM [6, 9].

Let's consider two cases:

◆ case 1. The task flow has a weak intensity. The case corresponds to a situation in which there are a few groups of students, and the stream of parallel sessions is not present. This case is simple, so it does not require careful consideration and conducting simulation experiments;

◆ case 2. Task flow received on CN has a high intensity. For example, groups of students have greater numbers, while classes are held in several concurrent streams, and there is a probability of the maximum load on a computer system.

Case 2 is the subject of experiments in the simulation model.

### 4. Experimental design

For the solution of practical problems in the assessment of the load on equipment and software when carrying out the practice, you must calculate and compare the indicators, carrying out the discipline under different conditions.

There has been designed a series of experiments which allow outputting under the following options of the organization of the discipline:

◆ experiment 1: These are a cloud-based service for one discipline with one stream of students;

◆ experiment 2: it is infrastructure for a single discipline and two streams of students;

◆ experiment 3: it is infrastructure for two disciplines (advanced experiment 2).

#### 4.1. Experiment 1.

##### Practical exercises are performed using the ERP system in the cloud

Conditions:

- the first week – 2 EM works that allow loading balance while simultaneously running 30 users on the lesson, the students perform the task with a rank of 2;
- the second week – the service has been work slowly, the number of EM decreases to 1, students perform tasks with a rank of 1;
- third and fourth weeks – the service is unavailable the first half of the total time, the second half – one EM runs, students perform the task with rank 1.

#### 4.2. Experiment 2.

##### The practical exercises are performed using the ERP system supported by the server infrastructure of the university

Conditions:

- server infrastructure supports two EPR systems of different manufacturers used to carry out practical tasks in two parallel groups of students (discipline 1) at the same time; the number of EM in infrastructure is equal to 2; it supports 30 users.
- the maximum rank of the tasks that can be performed by students – 1; the maximum number of students per group should not exceed 15.

#### 4.3. Experiment 3.

##### An extended version of Experiment 2

Conditions:

- conditions of the 2nd experiment;
- discipline 2 is taught at the university and students perform practical exercises using the ERP system supported by the server infrastructure of the university;
- days of discipline's classes does not coincide with the days of classes 1;
- students were learning discipline 2 and had not fulfilled the task during the basic training; they can come in to finish the job in extracurricular time;
- time of entrance of students into the system of extracurricular time is random.

In the process of conducting each experiment was performed ten runs, the averages presented in *Table 2*.

#### 4.4. Analysis of experimental results

The indicators “average delay before starting the task”, “residual in buffer”, “the number of failed exer-

cises” in the experiments 2 and 3 (*Table 2*) are considerably lower compared to experiment 1. In addition, you should also note that experiments 2 and 3 conducted for two and three simultaneous streams, and the number of assignments at the end of period per stream on average were almost 1/3 greater than the value of the same indicator for experiment 1 (*Table 2*).

Thus, the discipline carried out with the use of a cloud service ERP system is inferior by most measures to the options used the infrastructure to support the educational applications.

### 5. Comparing modelling results and the actual observations

Accumulated values of the indicators of *Table 1* were obtained as a consequence of the simulation experiment 1. *Figure 3* presents the results of one run, where NumStud1 – number of tasks executed in the class; NumStud2 – number of tasks executed before the deadline; NumStud3 – number of tasks executed with 1 week delay; NumStud4 – number of tasks executed with 2 weeks delays; NumStud5 – number of tasks that were not executed.

The conditions of the experiment 1 correspond to conditions in which there were practical lessons on the discipline “Corporate information systems” in the first semester. To determine where the data were obtained in the simulation result was reliable. Experiments were carried out to verify via actual observations. We made ten runs in experiment 1; the obtained average values for the totality runs for one of the simulated indicators (NumStud1), and the actual observations are shown in *Figure 4*. The comparison shows that the discrepancy between the results of numerical experiments and the actual data does not exceed 6.5%.

### Conclusion

This article has demonstrated an approach which is based on the use of simulation models for evaluating the load of the software which is being used during practical classes at the university. The problem of estimating the burden on the software is relevant for specialists involved in planning various aspects of academic disciplines using “heavy” software, for example, teachers, managers, curriculum specialists. Existing approaches are designed to measure the load at the beginning of the introduction or optimization of the already existing information systems. These are complex and at the same time do not provide the necessary information.

Table 2.

The experiment results

Indicator	Number of experiment		
	1	2	3
1. Average indicators for the modelling period from 22.09.16 12:10 to 15.12.16 15:00			
Speed of task execution (general)	0.605	0.597	0.592
Estimated time of student's occupation in class (hours)	1.36	0.96	0.95
Delay before starting the task (hours)	3.21	0.48	0.52
Task's explanation by the teacher (hours)	0.5	0.5	0.5
Number of tasks executing in extracurricular time (buffer)	32	12	30
Length of time between re-logins (minutes)	49	19	18
Number of system calls in extracurricular time	3	2	2
Uptime of the system (mean time to failure) (days)	12	30	30
Time during which the task is done in class (hours)	1.4	1.4	1.4
Duration of the execution of the task beyond class hours, in time before the deadline (days)	0.98	1.37	1.47
Length of time from the end of classes before the deadline (days)	2	2	2
Duration of the task's execution in extracurricular time with a delay of 1 week (days)	4.25	3.02	3.79
Duration of the task's execution in extracurricular time with a delay of 2 weeks (days)	11.5	0	0
2. Accumulated indicators for the modelling period from 22.09.16 12:10 to 15.12.16 15:00			
Number of tasks carried out in class	133	321 (160 tasks per stream)	467 (155 tasks per stream)
Number of tasks completed before deadline	48	291 (145 tasks per stream)	210 (70 tasks per stream)
Number of tasks that were completed 1 week late	57	172 (86 tasks per stream)	480 (160 tasks per stream)
Number of tasks that were completed 2 weeks late	63	0	0
Number of failed tasks	23	35 (17 tasks per stream)	68 (22 tasks per stream)
3. Residual indicators at the end of modelling period 15.12.16 15:00			
Tasks to be done in extracurricular time (buffer)	141	111 (55 tasks per stream)	170 (56 tasks per stream)
Completed tasks	301	784 (392 tasks per stream)	1157 (385 tasks per stream)

The model was developed based on an analysis of the results of using the cloud services of ERP applications in the educational process. It relies on various assumptions related to the influence of the infrastructure parameters (the server) on the duration of practical scenarios in ERP application. In fact, it can be used when planning preparation of lesson plans, in-

cluding the calculation of the volume of practical tasks. In addition to this, the model can be useful while defining the term in which it is possible to plan the teaching discipline along with calculating duration, the load of the teacher, the maximum number of students in the group, defining the hosting infrastructure (private server, cloud service) and so forth. ■



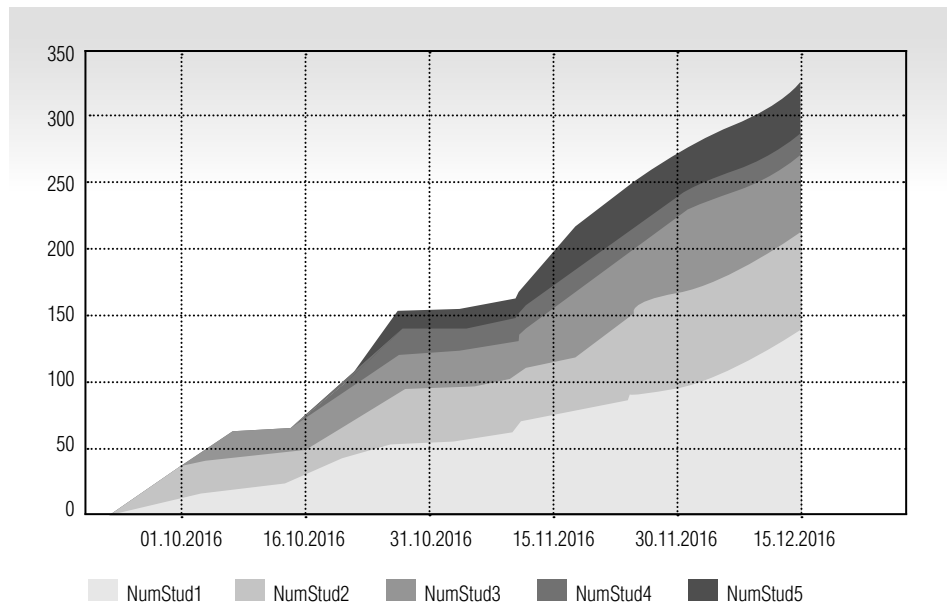

Fig. 3. The result of simulation experiment 1

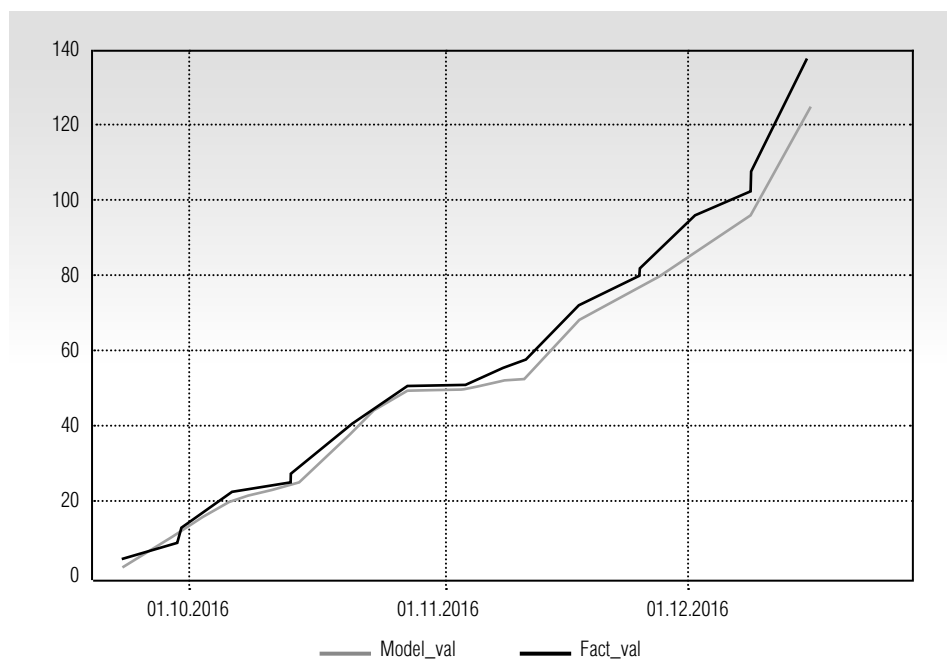

Fig. 4. Comparison of the results of experiment 1 and the actual observations

### References

1. Akopov A.S. (2014) *Imitatsionnoe modelirovanie* [Simulation modeling]. Moscow: Urait (in Russian).
2. Lychkina N.N. (2014) *Imitatsionnoe modelirovanie ekonomicheskikh protsessov* [Simulation modeling of economic processes]. Moscow: INFRA-M (in Russian).
3. Khoroshevsky V.G. (2008) *Arkhitektura vychislitel'nykh sistem* [Architecture of computer systems]. Moscow: BMSTU (in Russian).
4. Aliev T.I. (2009) *Osnovy modelirovaniya diskretnykh sistem* [Basics of discrete systems modeling]. Saint Petersburg: ITMO (in Russian).
5. Pavsky V.A., Pavsky K.V. (2008) Otsenka pokazatelya osushchestvivosti resheniya zadach na raspredelennykh vychislitel'nykh sistemakh [Evaluating feasibility of tasks solution on distributed computer systems]. *Tomsk State University Journal of Control and Computer Science*, no. 4 (5), pp. 61–68 (in Russian).

6. Saaty T.L. (2010) *Elementy teorii massovogo obsluzhivaniya i ee prilozheniya* [Elements of queueing theory with application]. Moscow: Librokom (in Russian).
7. Borshhev A.V. (2005) *Prakticheskoe agentnoe modelirovanie i ego mesto v arsenale analitika* [Practical agent based modeling and its place in an analyst's arsenal]. Available at: <http://www.gpss.ru/immod05/p/borshhev/print.html> (accessed 18 March 2017) (in Russian).
8. Pavlovsky Y.N., Belotelov N.V., Brodsky Y.I. (2008) *Imitatsionnoe modelirovanie* [Simulation modeling]. Moscow: Academy (in Russian).
9. Sidorenko V.N. Krasnoselsky A.V. (2009) *Imitatsionnoe modelirovanie v nauke i biznese: podkhody, instrumenty, primeneniye* [Simulation modeling in science and business: approaches, instruments, application]. *Business Informatics*, no. 2 (08), pp. 52–57 (in Russian).

## Имитационная модель поддержки планирования учебного процесса в высшем учебном заведении

### А.А. Горбунов

преподаватель кафедры управления информационными системами и цифровой инфраструктурой  
Национальный исследовательский университет «Высшая школа экономики»  
Адрес: 101000, г. Москва, ул. Мясницкая, д. 20  
E-mail: agorbinov@hse.ru

### Е.А. Исаев

кандидат технических наук  
профессор, заведующий кафедрой управления информационными системами и цифровой инфраструктурой  
Национальный исследовательский университет «Высшая школа экономики»  
Адрес: 101000, г. Москва, ул. Мясницкая, д. 20  
E-mail: eisaev@hse.ru

### А.Ф. Моргунов

кандидат технических наук  
доцент кафедры управления информационными системами и цифровой инфраструктурой  
Национальный исследовательский университет «Высшая школа экономики»  
Адрес: 101000, г. Москва, ул. Мясницкая, д. 20  
E-mail: amorgunov@hse.ru

#### Аннотация

В вузах и втузах с профильными ИТ-специальностями в одном семестре могут обучаться работе с программными продуктами сразу несколько потоков, курсов, специальностей. Поэтому перед ИТ-службами учебных заведений возникает задача создания инфраструктуры учебных приложений, которая сможет обеспечить поддержку учебного процесса. Следует учитывать, что число специальностей, на которых изучаются информационные технологии, с каждым годом растет (например, в НИУ ВШЭ преподаются дисциплины-майоры, куда может записаться студент с любой специальности). Также в последнее время популярностью стали пользоваться дистанционные курсы. Если не планировать нагрузку, то с учетом будущих трендов, мощности даже самой высокотехнологичной инфраструктуры будут недостаточны. Расчет соответствующей нагрузки на инфраструктуру необходимо производить в процессе планирования учебных дисциплин, что позволит выполнять резервирование соответствующих мощностей и тем самым организовать эффективный учебный процесс.

Разработчики программного обеспечения используют различные бенчмаркинг-инструменты, которые сложны и не предоставляют необходимой информации для участников планирования учебного процесса.

В статье рассматривается построение имитационной модели поддержки планирования учебного процесса. Моделирование осуществляется с использованием возможностей инструмента AnyLogic 7. Целью данной работы является разработка имитационной модели, предназначенной для оценки нагрузки на информационные системы, используемые в ходе учебного процесса. Помимо описания модели, в статье приведены результаты расчетов с ее использованием для различных вариантов размещения информационной системы (в частном облаке или на сервере в университете). Результаты моделирования подтверждены данными, полученными в ходе проведения практических занятий в вузе. Данная модель дает возможность планировать учебный процесс с целью добиться равномерности нагрузки на сервисы. В случае необходимости модель позволяет принять решение о месте размещения учебной информационной системы: на серверах университета или в частном облаке.

**Ключевые слова:** учебный процесс, информационная система, ERP-система, имитационная модель, частное облако, ИТ-инфраструктура.

**Цитирование:** Gorbunov A.A., Isaev E.A., Morgunov A.F. A simulation model for educational process planning in an institution of higher education // Business Informatics. 2017. No. 2 (40). P. 57–67.  
DOI: 10.17323/1998-0663.2017.2.57.67.

### Литература

1. Акопов А.С. Имитационное моделирование: Учебник и практикум для академического бакалавриата. М.: Юрайт, 2014.
2. Лычкина Н.Н. Имитационное моделирование экономических процессов: Учебное пособие. М.: ИНФРА-М, 2014.
3. Хорошевский В.Г. Архитектура вычислительных систем: Учебное пособие. М.: МГТУ им. Н.Э. Баумана, 2008.
4. Алиев Т.И. Основы моделирования дискретных систем. СПб: СПбГУ ИТМО, 2009.
5. Павский В.А., Павский К.В. Оценка показателей осуществимости решения задач на распределенных вычислительных системах // Вестник Томского государственного университета. Управление, вычислительная техника и информатика. 2008. № 4 (5). С. 61–68.
6. Саати Т.Л. Элементы теории массового обслуживания и ее приложения. М.: Либроком, 2010.
7. Борщев А.В. Практическое агентное моделирование и его место в арсенале аналитика. [Электронный ресурс]: <http://www.gpss.ru/immod05/p/borshev/print.html> (дата обращения 18.03.2017).
8. Павловский Ю.Н., Белотелов Н.В., Бродский Ю.И. Имитационное моделирование. Учебное пособие для студентов высших учебных заведений. М.: Академия, 2008.
9. Сидоренко В.Н., Красносельский А.В. Имитационное моделирование в науке и бизнесе: подходы, инструменты, применение // Бизнес-информатика. 2009. № 2 (08). С. 52–57.

# Architectural Solution as a tool for planning and approval of changes in projects for information systems implementation and customization

## Igor V. Ilyin

*Professor, Director of Graduate School of Business Technologies  
Peter the Great St. Petersburg Polytechnic University  
Address: 29, Polytechnicheskaya Street, St. Petersburg, 195251, Russian Federation  
E-mail: ivi2475@gmail.com*

## Anastasiia A. Grigoreva

*Doctoral Student, Graduate School of Business Technologies  
Peter the Great St. Petersburg Polytechnic University  
Address: 29, Polytechnicheskaya Street, St. Petersburg, 195251, Russian Federation  
E-mail: grigoreva\_spb@list.ru*

## Igor M. Zapivakhin

*Consultant on Integration, SOLMIX Consulting LLC;  
Master Student, Graduate School of Business Technologies  
Peter the Great St. Petersburg Polytechnic University  
Address: 29, Polytechnicheskaya Street, St. Petersburg, 195251, Russian Federation  
E-mail: igorzapivakhin@gmail.com*

### Abstract

The agile project management approach has been considered to be one of the most popular approaches for developing IT solutions. Use of this approach allows us to change the requirements at any stage of the IT project, and one of the twelve principles of Agile Manifesto, – “Simplicity”, – promotes the use of a minimum amount of project documentation. One of the disadvantages limiting the implementation in such resource-intensive projects as Information Systems Projects (ISP) is the risk of exceeding budgets and time limits. Therefore it is highly important to develop such a tool that will contribute in discussion and approval process with the customer before changes are started so as to minimize the possibilities of changes at further stages of the project.

This article investigates the possibility of applying holistic methods of the Enterprise Architecture (EA) in order to support solutions design during an Information System Project, in particular, in the form of documentation at the stage before implementation planning. The main aim of our research is to develop a tool that will help the customer to understand the planned changes and will contribute in that their influence on the already existing EA is taken into account. This article first reviews standards of IT project management in the context of recommendations for “conceptual project” outcomes. Next, the results of interviews conducted with IT consultants are presented. The proposed Architectural Solution (AS) is a document that completes the stage of design and coordinating IT changes. It is based on the application of methods and models from the field of EA. We believe this solution may be a sufficient document for coordinating projects that are conducted under agile philosophy.

**Key words:** Architectural Solution, IT project management, agile development methods, conceptual project, IT solution, information system, Enterprise Architecture, modelling language.

**Citation:** Ilyin I.V., Grigoreva A.A., Zapivakhin I.M. (2017) Architectural Solution as a tool for planning and approval of changes in projects for information systems implementation and customization. *Business Informatics*, no. 2 (40), pp. 68–78. DOI: 10.17323/1998-0663.2017.2.68.78.

## Introduction

Effective IT project management is one of the key factors that influences the quality of ending IT solutions [1]. In current practice, various life cycle models of information system (IS) development are used and combined. Also, a tendency has been observed towards the application of agile development methods in software productions. One feature of agile development methods is the lack of any requirement to consecutively complete the stages of project execution, with interim outcomes recorded in the form of project documentation [2]. Rejection of interim project documentation is not fully justified by the risk of increased expenditures on project management, which is relevant for the contractor, as the customer is able to modify customer requirements even in late stages of development [3]. At the same time, excessive documentation also negatively affects project expenditures.

In the competitive environment of consulting firms, when each strives to satisfy customers' requirements to the greatest extent and adapt to the current situation, project management is viewed by contractors as a sequence of "black boxes", the contents of which are opened during transition to the next phase of the project. According to the Capability Maturity Model Integration (CMMI) model, companies like this hold a position no higher than the third maturity level [4].

In the same time, the quality of project management processes is negatively influenced by the absence of the project execution team's understanding of the general decomposed scheme of the customer company business processes and their integration. For example, a specialist responsible for the automation and support of one company process may not understand how a "subordinate" process is related to and influences other linked business processes. In further IS use, disregard for these peculiarities can lead to uncontrolled changes in linked processes that were considered autonomous in the project's execution phase. In our opinion, the abovementioned problems may be prevented in the stage of planning, design and approval of project changes.

The aim of this study is to develop a tool that would allow consulting companies to get customer approval for planned IT changes within IS project before their real implementation, taking into account and coordinating both parties' comprehension of the aggregated diagram of the business processes.

This article is structured as follows.

The first part provides a brief review of IT project management standards containing recommendations

and drafts of IT project documentation. This is followed by the outcome of interviews with representatives of consulting companies involved in SAP ERP/CRM/BI-based solutions development. In the second part, the concept of an Architectural Solution (AS) is introduced and recommendations for its documentation are put forward. In the third part, a test of the proposed solution is applied in the form of case study from retail company practice. The article concludes with research findings and lays the path for future research.

## 1. Research methods

This study employed a qualitative method of data collection, summarization and analysis. Qualitative research methods, unlike quantitative methods, are aimed at a profound understanding of the situation in the context of myriad interrelationships among events and phenomena. Qualitative methods (analyses of scientific papers and literature content, interviews for a detailed understanding of the situation, observation of behavior, etc.) are recommended in the work [5] as the most appropriate approach to the development of new methods in the information system area.

### 1.1. Literature review

In analysis of literature in the field of IT project management, we have also included Enterprise Architecture Management (EAM) research literature, as Enterprise Architecture (EA) projects are considered by researchers to be a kind of IS projects upon condition that ending solutions provide system support to several organization's functional areas [6].

We have identified a line of research dedicated to the analysis of factors that influence communications during IT projects execution [7–12] within the design team and with key involved stakeholders, while the project's Enterprise Architect role [8, 9], that is, the representative of the contracted company, is considered to be responsible for the maintenance of effective communications between business stakeholders and IT team.

As a tool for the support of the effective communications between IT and business stakeholders, the authors [9, 10] have examined Enterprise Architecture models. In work [12] they comply with three primary objectives: documentation, analysis and planning enterprise aggregate design. It is noted in [13] that the design and state-of-the-art maintenance of models require significant effort and expense, therefore the production of models of the required level of detailing must serve the

purpose of the analysis [14] and meet the informational needs of the stakeholders but not to the purpose of just being.

Among the works of Russian researchers, it is important to note a work [15] that introduces the concept of an EAM solution. The documented EAM solution contains three parts: the methodological block, the technological block and the support and maintenance block. Such an idea serves the goals of documentation necessary for the execution and submission of architectural product documentation, including the description of the customer’s organizational processes and the integration of the solution with diverse company processes, as well as the transfer of recommendations on the support and maintenance of the implemented solution.

The documentation requirements in the context of an agile approach to software product development were considered in the works [16, 17], which recognize the necessity of the creation of solution designs in documentary form. The factors critical for the success of IT projects managed under agile principles are analyzed in the works [18, 19].

To sum up, as a result of the literature review, it is established that one of the factors that influences the success of IT projects (particularly projects managed with an agile approach) is communications during project activity between IT specialists (the project contractor) and stakeholders of various functional areas of the customer company. The maintenance of effective communications and execution of IT projects facilitates the creation of presentation materials and documents. So far, we have revealed a shortage of research focused on the development of design documentation in the planning and design solution approval phase. In our opinion, this subject is given unjustifiably little attention, as competent approval of planned changes in EA before their implementation phase decreases the likelihood of the introduction of later project changes, thus influencing IS project total cost.

**1.2. Evaluation of the current situation in the area of IT solution documentation**

This part of the article is dedicated to a review of solution design documentation practices and standards, which are used in IS-configured projects.

ADM TOGAF. The Open Group consortium develops a set of independent standards in the EA area [20]. One of them is the Architecture Development Method;

its cycle is depicted in *Figure 1*. The primary document of the architectural project (A-F ADM phases) is the Architecture Definition Document (ADD). This document describes various artifacts and perspectives of EA as building blocks for the creation of a holistic conception of architecture organization. The sections contained in the document include the project scope, goals and objectives, architectural principles, current and target architectures in business, application, data and technological segments, a gap analysis, as well as transition architecture creation and management.

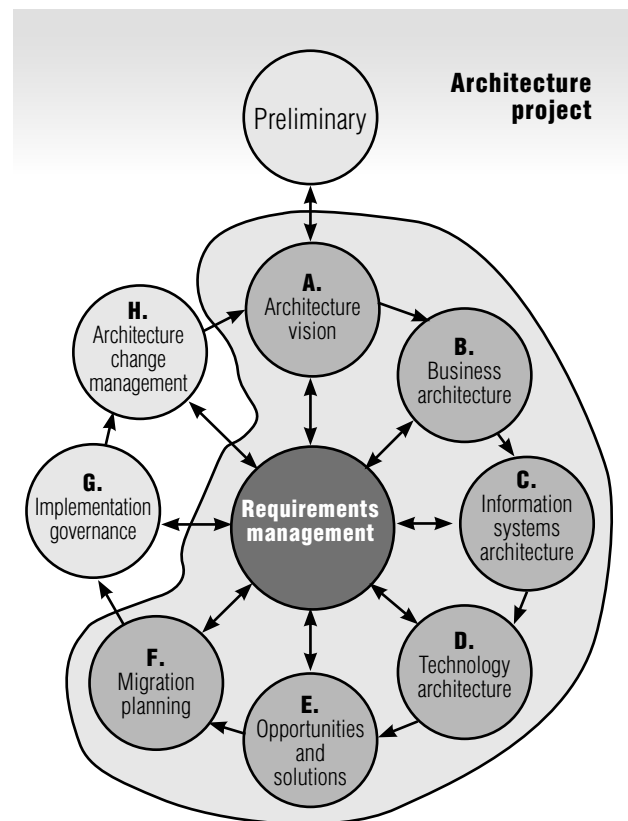

Fig. 1. EA development method and TOGAF Architectural Project [20]

RUP (Rational Unified Process) [21] supports an iterative software development approach that subdivides the software creation process into four main milestones: Inception, Elaboration, Construction, and Transition. Discussion and implemented solution choice is held in the Elaboration phase. A combination of eight documents, which conclude this phase, are established in the approach.

The GOST R ISO/IEC 12207-2010 standard [22] regulates the life cycle process of the software development and thus is the process standard. As indicated in the document, “the standard does not establish documentation

requirements in terms of its naming, format, specific content and recording media. These decisions are to be made by users of the standard" [22]. Annex C (*Cyrillic: B*) of the GOST R ISO/IEC 15271-02 standard bears the title "Classification of process output outcomes" and determines the process output outcomes that should be documented according to the requirements or recommendations of GOST R ISO/IEC 12207. The development stage allows for the creation of 37 documents (plans, protocols, descriptions, procedures, etc.).

To conclude, the analysis of existing standards and approaches to IT project management presented earlier as well discussed in works [23–26], revealed their redundancy and inflexibility in the creation of documentation of every project phase. The choice of what and what not to document is at the discretion of the business customer and IT solutions contractor. Not one document proposed in the considered IT related standards can be used as wholly sufficient in IT project management because they mostly were developed with the aim of complementing one another. The design of total EA according to ADD TOGAF is an excessively resource-draining process and is incompatible with agile philosophy.

### 1.3. Outcomes of interviews with consulting IT firms

Following the analysis of information from theoretical sources, we held interviews with representatives of Russian IT companies (KORUS, NOVARDIS, SOLMIX) on the subject of difficulties faced by IT teams during IS project execution. Interviews were held with consultants and market leaders about SAP ERP/CRM/ BI based solutions. Interviews were conducted with leaders and managers who are in charge of communications with high-level stakeholders as well as field consultants responsible for more technical issues: system requirements gathering, their processing and transfer for further development. In total, 12 people participated in the interviews.

In terms of particularly significant threats for IT projects, respondents cited the probability that projects may exceed budgets and timelines (11 out of 12). Specialists also described problems in getting approval for design changes caused by the customer's incomprehension of planned changes (7 out of 12), the problem of identifying and considering all interrelated processes during the development of local solutions, as well as problems with workflow, as large public enterprises are demanding of the workflow that frequently are based on government standards or internal strict methods. A total

rejection of creating design documentation during the implementation of ERP-based solutions seems highly unrealistic to specialists (12 out of 12).

The interviews established the need for the creation of a tool that in its documentary will be capable of recording planned system changes and will be comprehensible to the customer, by taking into account the influence of ongoing changes in linked business processes.

## 2. Architectural Solution

In the first part of the article, it was revealed that, on the one hand, multiple different approaches to IT project management exist in practice, as well as a range of supportive documents, each of which cannot be used in agile project management as a single document fully describing changes in IS. On the other hand, IT consultants have revealed difficulties in getting customers approval for changes at the design solution phase due to customers' frequent incomprehension of ongoing changes and lack of consideration of all processes addressed by the new solution.

### 2.1. Architectural Solution conception

In this part of the article, we introduce a new definition of the Architectural Solution (AS).

The **Architectural Solution** of an enterprise is an architectural domain model chosen and approved by all participating company business processes owners, which ensures maximum business competitiveness in a context of company resource limitations.

An architectural model is a holistic enterprise systems description characterized by a synergic effect achieved through its business and IT elements [27].

The Architectural Solution is aimed at resolving a specific business issue, taking user and organization management needs into consideration, and is unique to each organization. A documented AS confirmed with customer concludes the design, planning and change approval stage in IS implementation / customization projects. The AS approval is not so much about receiving the necessary signatures, than achieving the customer's comprehension of ongoing EA changes and their consequences.

AS is a much narrower concept than Enterprise Architecture (EA). Indeed, the EA target state is reached due to the implementation of a set of specific ASs, and they constitute the value of EA as a management tool for governing organizational changes.

In order to meet AS understandability requirements for business stakeholders who are not IT specialists, it is recommended to use visualization tools according to EA management practice, as well as explanations in natural language. Corporate architectural solutions, unlike software architecture models (systems), cannot be written exclusively in formal modeling and programming languages, as they are aimed at performing immediate business objectives and should be comprehensible to internal end-users and business stakeholders. Diagrams and descriptions should not be too complex, formal or otherwise inaccessible.

It is important to note a difference from the concept of “Solution Architecture”, which is target system architecture: architecture that implies a technical description of solution structure.

## 2.2. Documented AS

Generally, all fundamental project changes during IS implementation / customization are approved by the customer through the signing of corresponding documentation. The main task of the documentation is to describe and fix planned changes approved by the customer.

The AS document may be structured in the following manner:

- ◆ the introductory part, process goals and objectives;
- ◆ the list of process requirements, i.e. business, functional and user requirements (the list of requirements may vary depending on project goals);
- ◆ *the process model, input and output data: a visualized part of the processes, such as an activity diagram;*
- ◆ *the supporting systems model: set of systems, supporting the business processes, as well as infrastructure and information for IT specialists;*
- ◆ *a description of how an executed process affects linked business processes on an informational level;*
- ◆ *information received from the customer about planned tactical transformations in business activity and the considered domain.*

After the execution and implementation of IS changes, it is recommended to add information about what was done more or less incorrectly to the “AS” document, why this happened and how to manage this mistake from now on.

This document structure is an expanded version of a conceptual project from IT company practice (sections formerly not included in this document are indicated

in cursive). The additions are based on the Enterprise Architecture best practices and frameworks. As it was previously mentioned, EA management functions include modelling and documentation of EA state and IS systems to support organization’s evaluation and transformation, decision-making process, means of facilitating cooperation between the design team and the customer. Modelling in different views makes description comprehensible to a wide range of specialists [9, 12].

As it was previously mentioned, EA management functions include modelling and documentation of EA state and IS systems to support organization’s evaluation and transformation, decision-making process, means of facilitating cooperation between the design team and the customer.

In conclusion we can infer that better comprehension of ongoing changes from the customer’s point of view may be achieved by implementing approaches from Enterprise Architecture management in IS implementation / customization project communications. This will facilitate the communication of all relevant information on affected business processes and, in the long run, will lower the likelihood of changes introduced at later phases of the project. It is largely argued, that changes in later stages in IS project frequently occur because the influence of a certain business process to related processes was not taken into account during development.

## 3. Case study in retail: Online purchase on credit

The example presented in this section describes a retail case study about a new business process integration in the existing informational infrastructure project and the possibilities to use AS in the stage of the planning of changes in the customer system.

The primary activity of Household Appliances Company Ltd. is online sales of domestic appliances to retail customers. The company took the decision to offer customers the option of making orders on the online store and purchasing on credit. Formerly, purchases on credit were only available at distribution centers. By offering new services, the company intended to boost sales. Additionally, credit institutions and banks (external stakeholders) participated in the process’s execution, are motivated by the interest earned from credit sales.

Household Appliances Company Ltd. chose a contractor for the changes from among external IT companies with the main objective of integrating the new



process with the existing IS. After performing an on-site examination and gathering the new domain requirements, the IT specialists produced a document that should confirm the ongoing changes.

The “Solution Design” document structure was:

- 1) an introduction with a description of project goals and objectives, as well as expected outcomes;
- 2) a description of requirements, both high-level organization’s principles and requirements and middle-level requirements related to the most important functions, systems, and reports;
- 3) a description of business processes (business part);
- 4) a description for IT specialists (functional system requirements).

Let’s highlight the main points and analyze features. A large part of solution design is essentially a collection of requirements and expected outcome of a project. The expected outcomes of the project are determined based on information received from the customer and are found in “achievement of project goals”. Project goals include an increase in the number of customers buying goods on credit and the expected outcome from implementation, measured by key performance indicators.

The AS concept proposed earlier contains a section that takes connections with related business processes into account. In the given example, after an analysis

of Home Appliances Company Ltd., IT specialists revealed that the implemented online credit business process significantly overlaps the retail sales process in the online store. Considering that the description of the old process already exists and is used by the company when doing business, it does not have to be included in the AS model. *Figure 2* depicts the AS business layer, which describes only the missing elements of the new online credit business process. The graphic model was executed in an Archi environment. The existing retail sales process in the online store is highlighted by the dark background.

In order to execute the new process and implement it in existing IS design, it is necessary to re-design the company IS, adding a new functionality and after that to integrate it with an external credit broker system. On *Figure 3*, existing systems and their functionality are highlighted by dark background, while light grey background designates new IS elements, the developed functionality and services executed with the help of the new functionality.

*Figure 4* presents the hardware and software of the customer company, which will remain almost untouched by the implemented process. Changes highlighted by dark background refer to database expansion through the addition of tables containing customer data. Also the integration with an external broker system is added via the SOAP API method for messaging exchange.

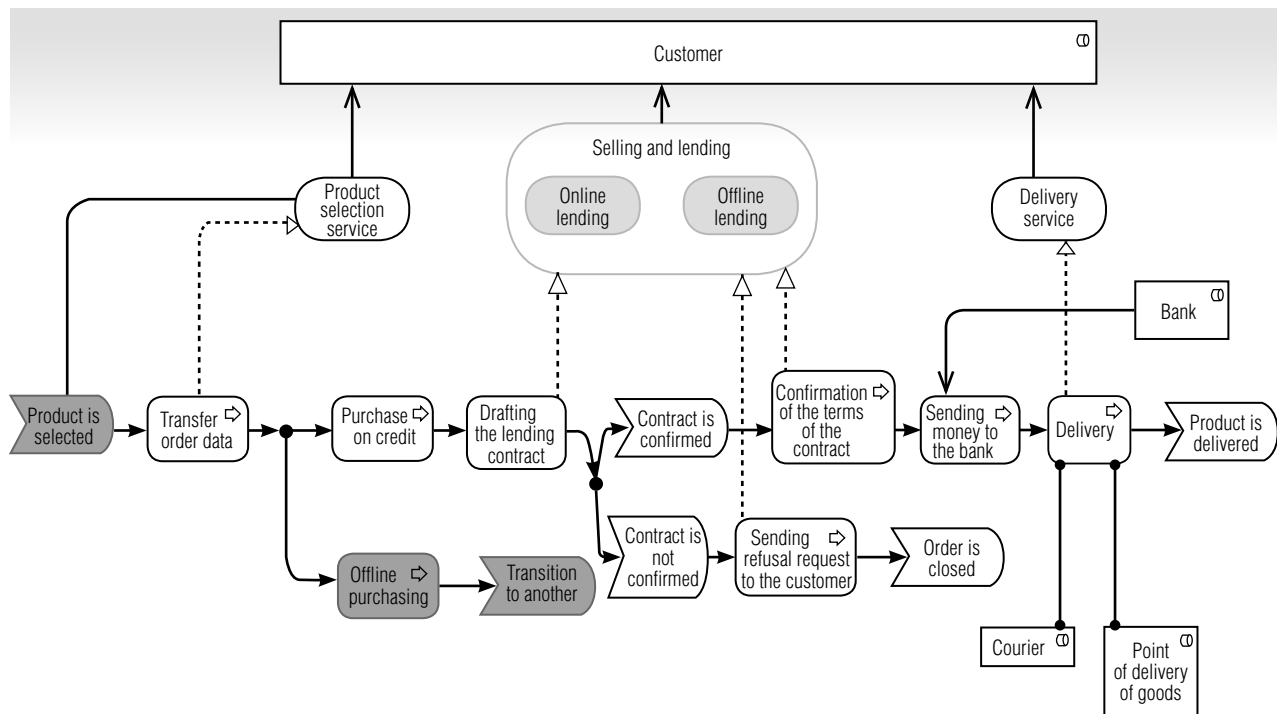

Fig. 2. Business description of the “Online purchase on credit” Architectural Solution

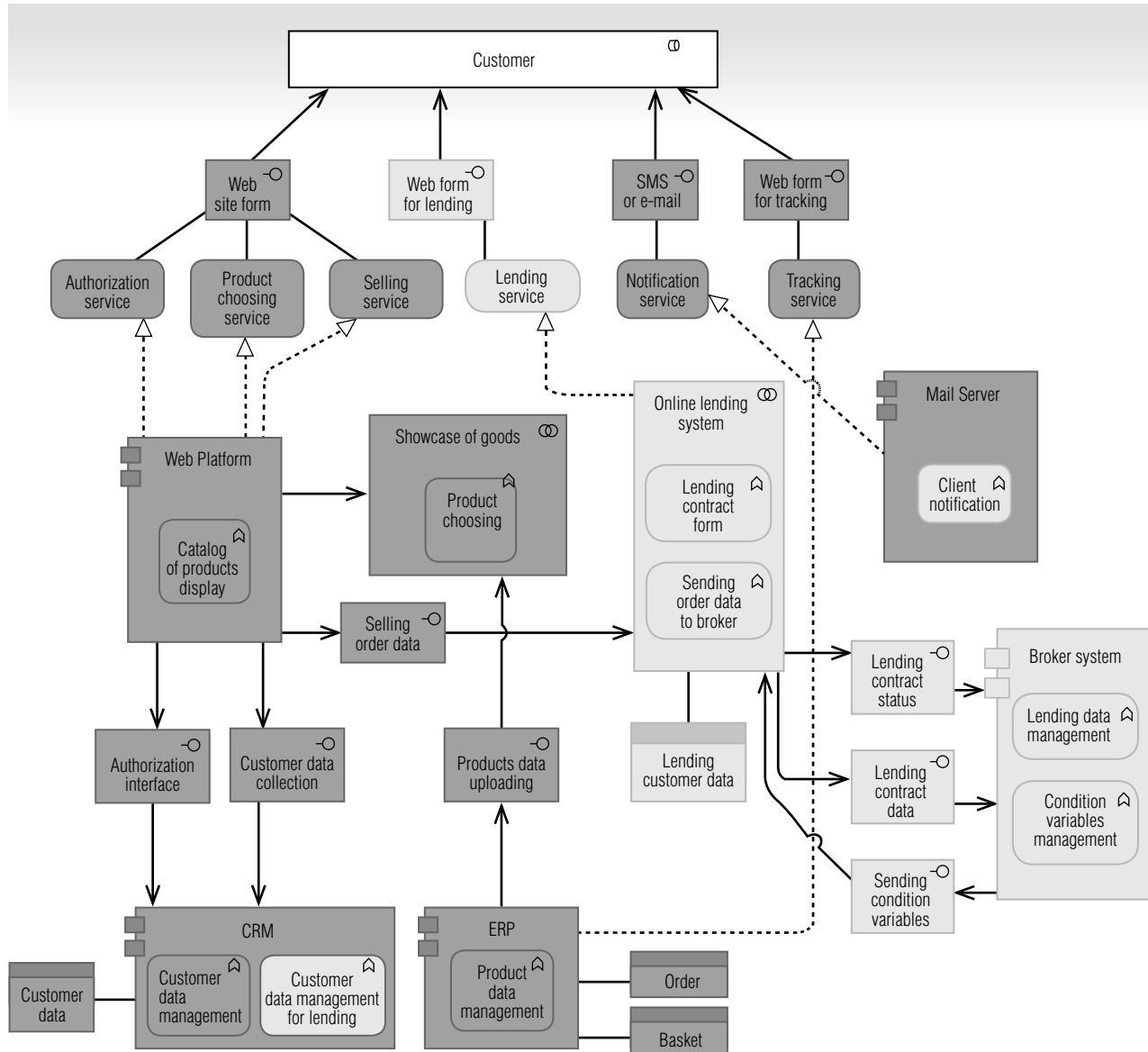

Fig. 3. Informational description of the “Online purchase on credit” Architectural Solution

**Conclusion**

In this article, we have introduced the authors’ definition of an Architectural Solution as an architectural model of a set domain approved by participating business processes owners and aimed at the solution of specific business objectives. Then, we presented the AS documentary form as a tool for approval of ongoing changes in Enterprise Architecture design with an emphasis on the high- and middle-level data visualization and the provision of information on related and affected business processes. The “AS” tool complements existing design documentation practice in the area of IS configuration through EAM approaches. Testing and ap-

plication of the proposed solution was conducted in the implementation of a new process of “online credit” in the existing IS design. The AS model was presented in three sections: business, information, and technological levels. The proposed solution may be used by consulting firms adhering to agile principles during project management in the areas of IS implementation / customization, and as a document in the IT solution design approval stage, minimizing the likelihood of changes in later stages of the project.

In terms of limitations, it should be noted that the design, planning and approval stage involves discussion and a choice among several alternatives; however, this

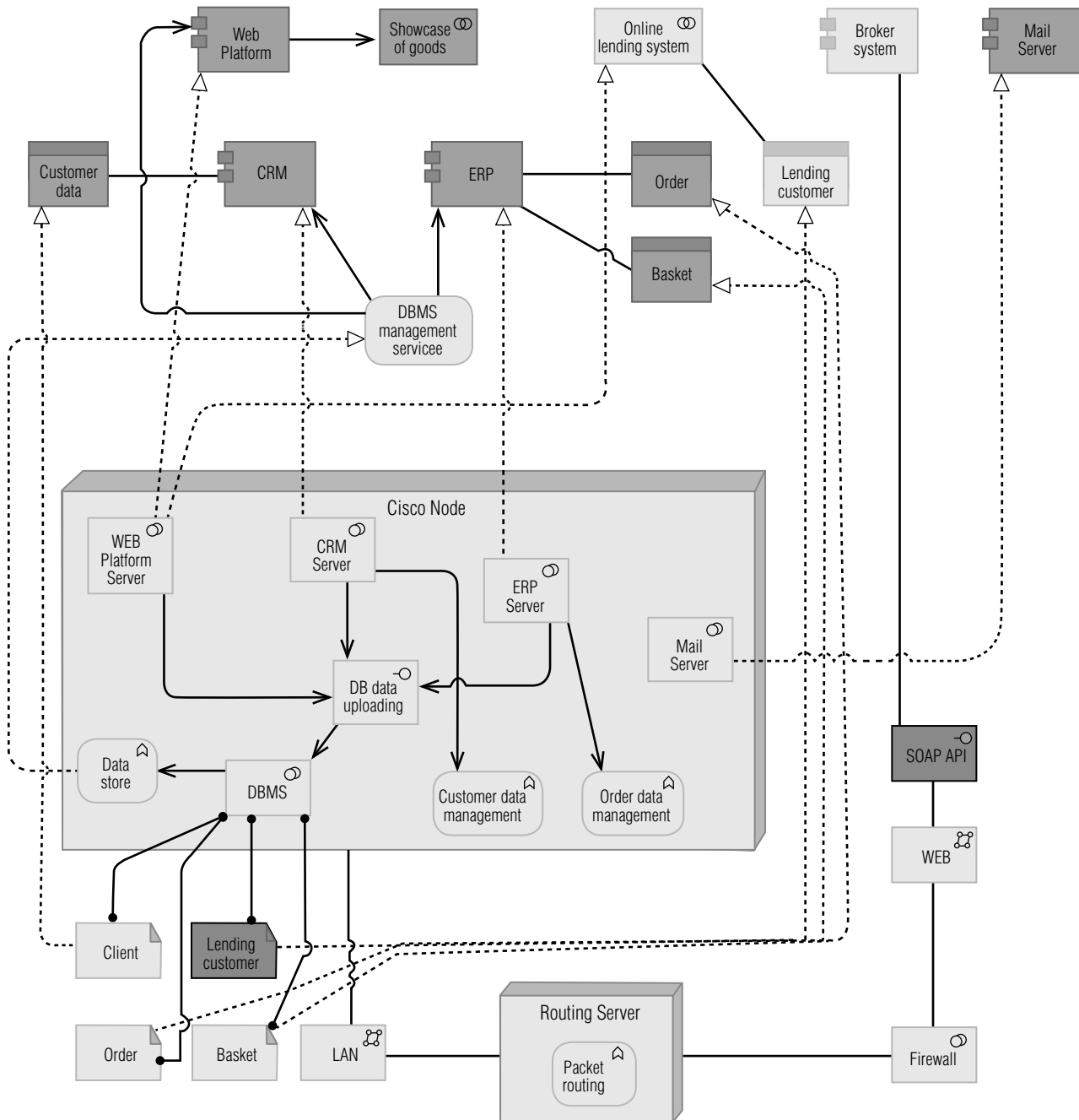

Fig. 4. Hardware and software description of the “Online purchase on credit” Architectural Solution

article does not cover the issue of several solutions parallel discussions and, consequently, the modelling of several AS. This issue should be addressed in the context of the situation, depending on the customer EA maturity [28] and the specific project requirements. Additionally, this article does not cover the issue of how to identify related processes that will be affected during AS implementation in the existing IS, which may become the subject of further study.

**Acknowledgements**

We would like to express our gratitude to the European Union for support of the Joint Programs and Framework for Doctoral Education in Software Engineering, “Pathways to PhD” (PWs@PhD) (<http://fase.it.lut.fi/>), as well as all universities participating in the project from Finland, Germany, the UK, Denmark, Russia and Jordan, for the opportunity to discuss the results of this study. ■

## References

1. Munns A.K., Bjeirmi B.F. (1996) The role of project management in achieving project success. *International Journal of Project Management*, vol. 14, no. 2. pp. 81–87.
2. Fowler M., Highsmith J. (2001) The Agile manifesto. *Software Development*, vol. 9, no. 8, pp. 28–35.
3. Kumar G., Bhatia P.K. (2012) Impact of Agile methodology on software development process. *International Journal of Computer Technology and Electronics Engineering*, vol. 2, no. 4, pp. 46–50.
4. Team C.P. (2006) *CMMI for Development*. Version 1.2.
5. Baskerville R., Myers M.D. (2004) Special issue on action research in information systems: Making IS research relevant to practice: Foreword. *MIS Quarterly*, vol. 28, no. 3. pp. 329–335.
6. Pulkkinen M. (2008) *Enterprise Architecture as a collaboration tool*. PhD thesis. Jyväskylä, Finland: University of Jyväskylä.
7. van der Raadt B., Schouten S., van Vliet H. (2008) Stakeholder perception of enterprise architecture. Proceedings of *Second European Conference on Software Architecture (ECSA 2008)*. Paphos, Cyprus, 29 September – 01 October 2008. Springer Berlin Heidelberg, pp. 19–34.
8. Smolander K., Paivarinta T. (2002) Describing and communicating software architecture in practice: Observations on stakeholders and rationale. Proceedings of the *Fourteenth International Conference on Advanced Information Systems Engineering (CAISE '02)*. Toronto, Canada, 27–31 May 2002. Springer Berlin Heidelberg, pp. 117–133.
9. Hirvonen A., Oyj T., Pulkkinen M. (2003) Evaluation of enterprise IT architecture solutions: How can an ICT consultant tell what is best for you? Proceedings of *10th European Conference on IT Evaluation*. Madrid, 25–26 September 2003. P. 327–337.
10. Sebastian R. (2011) Changing roles of the clients, architects and contractors through BIM. *Engineering, Construction and Architectural Management*, vol. 18, no. 2, pp. 176–187.
11. Nakakawa A., Bommel P., Proper H.A. (2010) Challenges of involving stakeholders when creating enterprise architecture. Proceedings of *5th SIKS/BENAIIS Conference on Enterprise Information Systems*. Eindhoven, The Netherlands, 16 November 2010, pp. 43–55.
12. Aier S., Gleichauf B. (2015) Application of enterprise models for engineering enterprise transformation. *Enterprise Modelling and Information Systems Architectures*, vol. 5, no. 1, pp. 58–75.
13. Aier S., Kurpjuweit S., Riege C., Saat J. (2008) Stakeholderorientierte dokumentation und analyse der unternehmensarchitektur. *INFORMATIK 2008: Beherrschbare Systeme – dank Informatik, München, 8–13 September 2008*, pp. 559–565.
14. Johnson P., Johansson E., Sommestad T., Ullberg J. (2007) A tool for Enterprise Architecture analysis. Proceedings of the *11th IEEE International Enterprise Distributed Object Computing Conference (EDOC 2007)*, Annapolis, Maryland, USA, 15–19 October 2007, pp. 142–142.
15. Koznov D.V., Arzumanyan M.Yu., Orlov Yu.V., Derevyanko M.A., Romanovsky K.Yu., Sidorina A.A. (2015) Specifics of projects in the area of Enterprise Architecture development. *Business Informatics*, no. 4 (34), pp. 15–23.
16. Mazni O., Sharifah-Lailee S.A., Azman Y. (2010). Agile documents: Toward successful creation of effective documentation. Proceedings of the *11th International Conference on Agile Software Development (XP 2010)*, Trondheim, Norway, 1–4 June 2010, pp. 196–201.
17. Rüping A. (2005). *Agile documentation: A pattern guide to producing lightweight documents for software projects*. John Wiley & Sons.
18. Chow T., Cao D.B. (2008) A survey study of critical success factors in agile software projects. *Journal of Systems and Software*, vol. 81, no. 6, pp. 961–971.
19. Power D.J., Sohal A.S., Rahman S.U. (2001) Critical success factors in agile supply chain management. An empirical study. *International Journal of Physical Distribution and Logistics Management*, vol. 31, no. 4, pp. 247–265.
20. The Open Group (2017) *The Open Group Architecture Framework (TOGAF)*. Version 9 “Enterprise Edition”. Available at: <http://www.opengroup.org/togaf/> (accessed 13 January 2004).
21. West D. (2002) *Planning a project with the Rational Unified Process*. Rational Whitepaper.
22. GOST R ISO/IEC 12207-2010 (2010) *Informatsionnaya tekhnologiya. Sistemnaya i programmaya inzheneriya. Protsessy zhiznennogo tsikla programmykh sredstv* [System and software engineering. Software life cycle processes]. Moscow: Standardinform (in Russian).
23. Bentley C. (2010). *Prince2: A practical handbook*. Routledge.
24. Wideman R.M. (2002) *Comparing PRINCE2® with PMBoK®*. Vancouver, Canada: AEW Services.
25. GOST 34.601-90 (1990) *AS. Stadii sozdaniya* [Automated systems. Stages of development.]. Moscow: Standardinform (in Russian).
26. Bourque P., Fairley R.E. (2014) *Guide to the software engineering body of knowledge (SWEBOK (R))*. Version 3.0. IEEE Computer Society Press.
27. Lankhorst M.M. (2004) Enterprise Architecture modelling – the issue of integration. *Advanced Engineering Informatics*, vol. 18, no. 4, pp. 205–216.
28. Ilyin I.V., Levina A.I. (2015) Upravlenie zrelost'yu biznes arkhitektury predpriyatiya [Business architecture maturity management]. *St. Petersburg State Polytechnical University Journal. Economics*, no. 2 (216), pp. 109–117 (in Russian).

# Архитектурное Решение как инструмент планирования и согласования изменений в проектах внедрения и кастомизации информационных систем

## И.В. Ильин

*доктор экономических наук, профессор,  
директор Высшей школы технологий управления бизнесом,  
Санкт-Петербургский политехнический университет Петра Великого  
Адрес: 195251, г. Санкт-Петербург, ул. Политехническая, д. 29  
E-mail: ivi2475@gmail.com*

## А.А. Григорьева

*аспирант Высшей школы технологий управления бизнесом,  
Санкт-Петербургский политехнический университет Петра Великого  
Адрес: 195251, г. Санкт-Петербург, ул. Политехническая, д. 29  
E-mail: grigoreva\_spb@list.ru*

## И.М. Запивахин

*консультант по интеграции ООО «СОЛМИКС Консалтинг»;  
студент магистратуры Высшей школы технологий управления бизнесом,  
Санкт-Петербургский политехнический университет Петра Великого  
Адрес: 195251, г. Санкт-Петербург, ул. Политехническая, д. 29  
E-mail: igorzapivakhin@gmail.com*

### Аннотация

В настоящее время среди специалистов сферы ИТ выявлены предпочтения к использованию на практике семейства гибких (agile) методологий управления проектами. Использование данных методологий подразумевает возможность внесения изменений в требования к ИТ-решению на любом этапе, а один из принципов Agile Manifesto, – «Простота», – декларирует использование минимума проектной документации. Недостаток данного подхода при ведении таких ресурсозатратных проектов, как проекты в области настройки информационных систем (ИС) заключается в рисках исполнителя не соблюсти временные и бюджетные рамки проекта. Возникает необходимость в создании инструмента, который будет согласовать планы на разработку до ее непосредственной реализации таким образом, чтобы свести к минимуму вероятность внесения изменений на более поздних этапах проекта.

В статье представлены результаты исследования возможности применения холистических методов визуализации из области управления архитектурой предприятия (АП) (Enterprise Architecture Management, EAM) к сопровождению проектных работ по внедрению и кастомизации ИС, в частности, к составлению документации на стадии планирования и согласования ИТ-решений. Цель работы – разработать инструмент, который будет способствовать пониманию заказчиком планируемых изменений, и обеспечит учет их влияния на уже существующую АП. В данной статье анализируются стандарты к управлению ИТ-проектами в части рекомендаций по составлению проектной документации этапа «концептуальный проект», а также приводятся результаты опросов ИТ-консультантов. Предложено Архитектурное Решение (АР) – документ, завершающий стадию планирования и согласования ИТ-изменений, который базируется на использовании методов и моделей из области АП. Данное решение при agile-философии ведения ИТ-проектов может являться достаточным документом этапа согласования планов на проект.

**Ключевые слова:** Архитектурное Решение, управление ИТ-проектами, гибкие методологии разработки, концептуальный проект, ИТ-решение, информационная система, архитектура предприятия, язык моделирования.

**Цитирование:** Ilyin I.V., Grigoreva A.A., Zapivakhin I.M. Architectural Solution as a tool for planning and approval of changes in projects for information systems implementation and customization // Business Informatics. 2017. No. 2 (40). P. 68–78. DOI: 10.17323/1998-0663.2017.2.68.78.

## Литература

1. Munns A.K., Bjeirmi B.F. The role of project management in achieving project success // *International Journal of Project Management*. 1996. Vol. 14. No. 2. P. 81–87.
2. Fowler M., Highsmith J. The Agile manifesto // *Software Development*. 2001. Vol. 9. No. 8. P. 28–35.
3. Kumar G., Bhatia P.K. Impact of Agile methodology on software development process // *International Journal of Computer Technology and Electronics Engineering*. 2012. Vol. 2. No. 4. P. 46–50.
4. Team C.P. CMMI for Development. Version 1.2. 2006.
5. Baskerville R., Myers M.D. Special issue on action research in information systems: Making IS research relevant to practice: Foreword // *MIS Quarterly*. 2004. Vol. 28. No. 3. P. 329–335.
6. Pulkkinen M. Enterprise Architecture as a collaboration tool. PhD thesis. Jyväskylä, Finland: University of Jyväskylä, 2008.
7. van der Raadt B., Schouten S., van Vliet H. Stakeholder perception of enterprise architecture // *Second European Conference on Software Architecture (ECSA 2008)*. Paphos, Cyprus, 29 September – 01 October 2008. Springer Berlin Heidelberg, 2008. P. 19–34.
8. Smolander K., Paivarinta T. Describing and communicating software architecture in practice: Observations on stakeholders and rationale // *The Fourteenth International Conference on Advanced Information Systems Engineering (CAiSE '02)*. Toronto, Canada, 27–31 May 2002. Springer Berlin Heidelberg, 2002. P. 117–133.
9. Hirvonen A., Oyj T., Pulkkinen M. Evaluation of enterprise IT architecture solutions: How can an ICT consultant tell what is best for you? // *10th European Conference on IT Evaluation*. Madrid, 25–26 September 2003. P. 327–337.
10. Sebastian R. Changing roles of the clients, architects and contractors through BIM // *Engineering, Construction and Architectural Management*. 2011. Vol. 18. No. 2. P. 176–187.
11. Nakakawa A., Bommel P., Proper H.A. Challenges of involving stakeholders when creating enterprise architecture // *5th SIKS/BENAIIS Conference on Enterprise Information Systems*. Eindhoven, The Netherlands, 16 November 2010. P. 43–55.
12. Aier S., Gleichauf B. Application of enterprise models for engineering enterprise transformation // *Enterprise Modelling and Information Systems Architectures*. 2015. Vol. 5. No. 1. P. 58–75.
13. Aier S., Kurpjuweit S., Riege C., Saat J. Stakeholderorientierte dokumentation und analyse der unternehmensarchitektur // *INFORMATIK 2008: Beherrschbare Systeme – dank Informatik*. München, 8–13 September 2008. P. 559–565.
14. Johnson P., Johansson E., Sommestad T., Ullberg J. A tool for Enterprise Architecture analysis // *11th IEEE International Enterprise Distributed Object Computing Conference (EDOC 2007)*. Annapolis, Maryland, USA. 15–19 October 2007. P. 142–142.
15. Specifics of projects in the area of Enterprise Architecture development / D.V. Koznov et al. // *Business Informatics*. 2015. No. 4 (34). P. 15–23.
16. Mazni O., Sharifah-Lailee S.A., Azman Y. Agile documents: Toward successful creation of effective documentation // *11th International Conference on Agile Software Development (XP 2010)*. Trondheim, Norway. 1–4 June 2010. P. 196–201.
17. Rüping A. Agile documentation: A pattern guide to producing lightweight documents for software projects. John Wiley & Sons, 2005.
18. Chow T., Cao D.B. A survey study of critical success factors in agile software projects // *Journal of Systems and Software*. 2008. Vol. 81. No. 6. P. 961–971.
19. Power D.J., Sohal A.S., Rahman S.U. Critical success factors in agile supply chain management. An empirical study // *International Journal of Physical Distribution and Logistics Management*. 2001. Vol. 31. No. 4. P. 247–265.
20. The Open Group Architecture Framework (TOGAF). Version 9 “Enterprise Edition”. [Электронный ресурс]: <http://www.opengroup.org/togaf/> (дата обращения 15.03.2017).
21. West D. Planning a project with the rational unified process. Rational Whitepaper, 2002.
22. ГОСТ Р ИСО/МЭК 12207-2010. Информационная технология. Системная и программная инженерия. Процессы жизненного цикла программных средств. М.: Стандартинформ, 2010.
23. Bentley C. Prince2: A practical handbook. Routledge, 2010.
24. Wideman R.M. Comparing PRINCE2® with PMBoK®. Vancouver, Canada: AEW Services, 2002.
25. ГОСТ 34.601-90. АС. Стадии создания. М.: Стандартинформ, 1990.
26. Bourque P., Fairley R.E. Guide to the software engineering body of knowledge (SWEBOOK (R)). Version 3.0. IEEE Computer Society Press, 2014.
27. Lankhorst M.M. Enterprise Architecture modelling – the issue of integration // *Advanced Engineering Informatics*. 2004. Vol. 18. No. 4. P. 205–216.
28. Ильин И.В., Левина А.И. Управление зрелостью бизнес архитектуры предприятия // *Научно-технические ведомости Санкт-Петербургского государственного политехнического университета. Экономические науки*. 2015. № 2 (216). С. 109–117.

# AUTHORS GUIDELINES

Articles should be topical and original, should outline tasks (issues), describe key results of the author's research and appropriate conclusions.

Manuscripts are submitted via e-mail: [bijournal@hse.ru](mailto:bijournal@hse.ru).

## MANUSCRIPT REQUIREMENTS

**TEXT FILES** should be submitted in electronic form, as a MS Word document (version 2003 or higher).

**LENGTH.** Articles should be between 20 and 25 thousand characters (incl. spaces).

**FONT, SPACING, MARGINS.** The text should be in Times New Roman 12 pt, 1.5 spaced, fit to the width, margins: left – 25 mm, all other – 15 mm.

**TITLE** of the article should be submitted in native language and English.

**AUTHORS' DETAILS** are presented in native language and English. The details include:

- ◆ Full name of each author
- ◆ Position, rank, academic degree of each author
- ◆ Affiliation of each author, at the time the research was completed
- ◆ Full postal address of each affiliation (incl. postcode / ZIP)
- ◆ E-mail address of each author.

**ABSTRACT** are presented in native language and English.

- ◆ The abstract should be between 200 and 300 words.
- ◆ The abstract should be informative (no general words), original, relevant (reflects your paper's key content and research findings); structured (follows the logics of results' presentation in the paper)
  - ◆ The recommended structure: purpose (mandatory), design / methodology / approach (mandatory), findings (mandatory), research limitations / implications (if applicable), practical implications (if applicable), originality / value (mandatory).
- ◆ It is appropriate to describe the research methods/methodology

if they are original or of interest for this particular research. For papers concerned with experimental work the data sources and data procession technique should be described.

- ◆ The results should be described as precisely and informatively as possible. Include your key theoretical and experimental results, factual information, revealed interconnections and patterns. Give special priority in the abstract to new results and long-term impact data, important discoveries and verified findings that contradict previous theories as well as data that you think have practical value.

- ◆ Conclusions may be associated with recommendations, estimates, suggestions, hypotheses described in the paper.

- ◆ Information contained in the title should not be duplicated in the abstract. Authors should try to avoid unnecessary introductory phrases (e.g. «the author of the paper considers...»).

- ◆ Authors should use the language typical of research and technical documents to compile your abstract and avoid complex grammatical constructions.

- ◆ The text of the abstract should include key words of the paper.

**KEYWORDS** are presented in native language and English. The number of key words / words combinations are from 6 to 10 (separated by semicolons).

**FORMULAE** should be prepared using Math Type or MS Equation tool.

**FIGURES** should be of high quality, black and white, legible and numbered consecutively with Arabic numerals. All figures (charts, diagrams, etc.) should be submitted in electronic form (photo images – in TIF, PSD or JPEG formats, minimum resolution 300 dpi). Appropriate references in the text are required.

**REFERENCES** should be presented in Harvard style and carefully checked for completeness, accuracy and consistency.

The publication is free of charge.

Представляемая для публикации статья должна быть актуальной, обладать новизной, отражать постановку задачи (проблемы), описание основных результатов исследования, выводы, а также соответствовать указанным ниже правилам оформления.

Текст должен быть тщательно вычитан автором, который несет ответственность за научно-теоретический уровень публикуемого материала.

Материалы представляются в электронном виде по адресу:  
bijournal@hse.ru.

## ТРЕБОВАНИЯ К ОФОРМЛЕНИЮ СТАТЕЙ

**ТЕКСТ СТАТЬИ** представляется в редакцию в электронном виде (в формате MS Word, версия 2003 или выше).

**ОБЪЕМ.** Ориентировочный объем статьи составляет 20-25 тысяч знаков (с пробелами).

### ШРИФТ, ФОРМАТИРОВАНИЕ, НУМЕРАЦИЯ СТРАНИЦ

**ШРИФТ** – Times New Roman, кегль набора – 12 пунктов, полуторный интервал, форматирование по ширине. Нумерация страниц – вверху по центру, поля: левое – 2,5 см, верхнее, нижнее и правое – по 1,5 см.

**НАЗВАНИЕ СТАТЬИ** приводится на русском и английском языках. Название статьи должно быть информативным и раскрывать содержание статьи.

**СВЕДЕНИЯ ОБ АВТОРАХ** приводятся на русском и английском языках и включают следующие элементы:

- ◆ фамилия, имя, отчество всех авторов полностью
- ◆ должность, звание, ученая степень каждого автора
- ◆ полное название организации – места работы каждого автора в именительном падеже, полный почтовый адрес каждой организации (включая почтовый индекс)
- ◆ адрес электронной почты каждого автора.

**АННОТАЦИЯ К СТАТЬЕ** представляется на русском и английском языках.

- ◆ Объем – 200-300 слов.
- ◆ Аннотация должна быть информативной (не содержать общих слов).
- ◆ Аннотация должна отражать основное содержание статьи и быть структурированной (следовать логике описания результатов в статье).
- ◆ Структура аннотации: предмет, цель, метод или методологию проведения исследования, результаты исследований, область их применения, выводы.
- ◆ Метод или методологию проведения исследований целесообразно описывать в том случае, если они отличаются новизной или представляют интерес с точки зрения данной работы. В аннотациях статей, описывающих экспериментальные работы, указывают источники данных и характер их обработки.
- ◆ Результаты работы описывают предельно точно и информативно. Приводятся основные теоретические и экспериментальные результаты, фактические данные, обнаруженные взаимосвязи и закономерности. При этом отдается предпочтение новым результатам и дан-

ным долгосрочного значения, важным открытиям, выводам, которые опровергают существующие теории, а также информации, которая, по мнению автора, имеет практическое значение.

- ◆ Выводы могут сопровождаться рекомендациями, оценками, предложениями, гипотезами, описанными в статье.
- ◆ Сведения, содержащиеся в названии статьи, не должны повторяться в тексте аннотации. Следует избегать лишних вводных фраз (например, «автор статьи рассматривает...»).
- ◆ Исторические справки, если они не составляют основное содержание документа, описание ранее опубликованных работ и общеизвестные положения, в аннотации не приводятся.
- ◆ В тексте аннотации следует употреблять синтаксические конструкции, свойственные языку научных и технических документов, избегать сложных грамматических конструкций.
- ◆ В тексте аннотации следует применять значимые слова из текста статьи.

**КЛЮЧЕВЫЕ СЛОВА** приводятся на русском и английском языках. Количество ключевых слов (словосочетаний) – 6-10. Ключевые слова или словосочетания отделяются друг от друга точкой с запятой.

**ФОРМУЛЫ.** При наборе формул, как выключных, так и строчных, должен быть использован редактор формул MS Equation. В формульных и символических записях греческие (русские) символы, а также математические функции записываются прямыми шрифтами, а переменные аргументы функций в виде английских (латинских) букв – наклонным курсивом (пример «cos a», «sin b», « $\pi$ in», «max»). Нумерация формул – сквозная (по желанию авторов допускается двойная нумерация формул с указанием структурного номера раздела статьи и, через точку, номера формулы в разделе).

**РИСУНКИ** (графики, диаграммы и т.п.) могут быть оформлены средствами MS Word или MS Excel. Ссылки на рисунки в тексте обязательны и должны предшествовать позиции размещения рисунка. Допускается использование графического векторного файла в формате wmf/emf или cdr v.10. Фотографические материалы предоставляются в формате TIF или JPEG, с разрешением изображения не менее 300 точек на дюйм. Нумерация рисунков – сквозная.

**ТАБЛИЦЫ** оформляются средствами MS Word или MS Excel. Нумерация таблиц – сквозная.

**СПИСОК ЛИТЕРАТУРЫ** составляется в соответствии с требованиями ГОСТ 7.0.5-2008. Библиографическая ссылка (примеры оформления размещены на сайте журнала <http://bi.hse.ru/>). Нумерация библиографических источников – в порядке цитирования. Ссылки на иностранную литературу – на языке оригинала без сокращений.

**СПИСОК ЛИТЕРАТУРЫ ДЛЯ АНГЛОЯЗЫЧНОГО БЛОКА** оформляется в соответствии с требованиями SCOPUS (примеры оформления размещены на сайте журнала <http://bi.hse.ru/>). Для транслитерации русскоязычных наименований можно воспользоваться сервисом <http://translit.ru/>.

## ЛИЦЕНЗИОННЫЙ ДОГОВОР

Для размещения полнотекстовых версий статей на сайте журнала с авторами заключается лицензионный договор о передаче авторских прав.

Плата с авторов за публикацию рукописей не взимается.